



Push-Buttons and Visual indicators

Catalogue PDOC00018UK02-ev



 **WARNING**

FAILURE OR IMPROPER SELECTION OR IMPROPER USE OF THE PRODUCTS AND/OR SYSTEMS DESCRIBED HEREIN OR RELATED ITEMS CAN CAUSE DEATH, PERSONAL INJURY AND PROPERTY DAMAGE.

This document and other information from Parker Hannifin Corporation, its subsidiaries and authorized distributors provide product and/or system options for further investigation by users having technical expertise. It is important that you analyze all aspects of your application and review the information concerning the product or system in the current product catalog. Due to the variety of operating conditions and applications for these products or systems, the user, through its own analysis and testing, is solely responsible for making the final selection of the products and systems and assuring that all performance, safety and warning requirements of the application are met. The products described herein, including without limitation, product features, specifications, designs, availability and pricing, are subject to change by Parker Hannifin Corporation and its subsidiaries at any time without notice.

SALE CONDITIONS

The items described in this document are available for sale by Parker Hannifin Corporation, its subsidiaries or its authorized distributors. Any sale contract entered into by Parker will be governed by the provisions stated in Parker's standard terms and conditions of sale (copy available upon request).

Page

Push button valves Ø 22

Generalities	4
Spring return pushbuttons	4
Mushroom head pushbuttons	4
Selector switches	5
Switch bodies with operating head mounting	5
Additional switch valves	5
Electrical contact blocks	5
Mounting block for valves and operating heads	6
Operating heads	6 - 7
Joystick controllers	7
Dimensions and assembling	8

Visual indicators

Generalities	9
References and dimensions	10

- Facia mounted operator
- 3/2 NO or NC
- Pneumatic valves combinable with electrical switches
- Modular construction (up to 3 valves per pushbuttons heads)
- Wide range of actuators

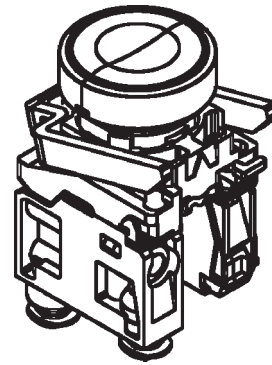

Operating and additional information

Working pressure

PXB-B3••	1 to 9 bar
PXB-B4••	1 to 10 bar

Working temperature

-15 °C to +60 °C

Flow

(acc. to ISO 6358)

PXB-B3••	Q _{max} =60 l/min Q _n = 30 l/min
-----------------	---

PXB-B4••	Q _{max} =240 l/min Q _n = 120 l/min
-----------------	---

Connections

Ø4 mm straight Push-in as standard
Ø4 mm swivel Push-in on request
M5 on request

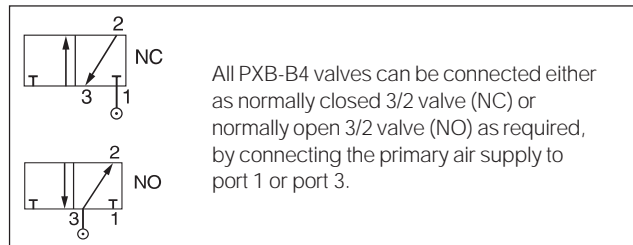







Spring return pushbuttons - Metal head version - Ø 4 mm straight fittings

Symbol	Actuator	Return	Operating force at 6 bar, N	Flow NI/min	Weight kg	Order code
	Pushbutton Black	Spring	8,5 6,0	60 240	0,077 0,082	PXB-B3111BA2 PXB-B4131BA2
	Pushbutton Green	Spring	8,5 6,0	60 240	0,077 0,082	PXB-B3111BA3 PXB-B4131BA3
	Pushbutton Red	Spring	8,5 6,0	60 240	0,077 0,082	PXB-B3111BA4 PXB-B4131BA4
	Pushbutton Black	Spring	16,5 14,0	60 240	0,087 0,092	PXB-B3251BA2 PXB-B4231BA2

Mushroom head pushbuttons - Metal head version - Ø 4 mm straight fittings

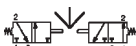

Symbol	Actuator	Return	Operating force at 6 bar, N	Flow NI/min	Weight kg	Order code
	Pushbutton Ø40 mm Black	Spring	12 6,5	60 240	0,122 0,127	PXB-B3111BC2 PXB-B4131BC2
	Latching pushbutton Ø40 mm Red		48 42,5	60 240	0,125 0,127	PXB-B3111BT4 PXB-B4131BT4
	Latching pushbutton Ø40 mm Red		49 43,5	60 240	0,125 0,127	PXB-B3121BT4 PXB-B4131BT4

Selector switches - Metal head version - Ø 4 mm straight fittings

Symbol	Actuator	Return	Flow NI/min	Weight kg	Order code
	Latching selector button 2 positions, Black		60	0,092	PXB-B3111BD2
			240	0,097	PXB-B4131BD2
	Latching selector button 2 positions, Black		60	0,102	PXB-B3211BD2
			240	0,107	PXB-B4231BD2
	Latching selector button 2 positions, Black		60	0,102	PXB-B3251BD2
			240	0,107	PXB-B4231BD2
	Latching selector button 3 positions, Black		60	0,102	PXB-B3211BD3
			240	0,107	PXB-B4231BD3
	Latching selector button 3 positions, Black		60	0,102	PXB-B3251BD3
			240	0,107	PXB-B4231BD3
	Non latching selector button with long handle 3 positions, Black	Spring	60	0,103	PXB-B3211BJ5
			240	0,108	PXB-B4231BJ5





Switch bodies with operating metal head mounting - Ø 4 mm straight fittings

For use with ZB4 operating heads



Symbol	Actuator	Return	Operating force at 6 bar, N	Flow NI/min	Weight kg	Order code
	Plunger	Spring	7	60	0,048	PXB-B3111B
			4,5	240	0,053	PXB-B4131B
	Plunger	Spring	8	60	0,048	PXB-B3121B
			4,5	240	0,053	PXB-B4131B

Additional switch valves - Ø 4 mm straight fittings

For use with ZB4 and ZB5 operating heads and mounting blocks

Symbol	Actuator	Return	Operating force at 6 bar, N	Flow NI/min	Weight kg	Order code
	Plunger Straight connection	Spring	7	60	0,010	PXB-B3911
			4,5	240	0,015	PXB-B4931
	Plunger Straight connection	Spring	8	60	0,010	PXB-B3921
			4,5	240	0,015	PXB-B4931
	Plunger Swivel connection	Spring	7	60	0,015	PXB-B3912
			4,5	240	0,021	PXB-B4932
	Plunger Swivel connection	Spring	8	60	0,015	PXB-B3922
			4,5	240	0,021	PXB-B4932

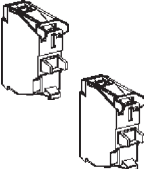
Electrical contact blocks

Connections	Type of contact	Weight kg	Order code
	Normally open (NO) 	0,011	ZBE-101
	Normally closed (NC) 	0,011	ZBE-102

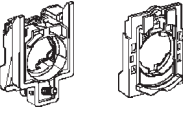

Mounting block for valves and operating heads

Description	For Metal head ZB4		For Plastic head ZB5	
	Weight kg	Order code	Weight kg	Order code
 <p>Mounting block for valves and operating heads: to make up a complete push button with one operating head and switch valves.</p>	0,038	ZB4-BZ009	0,006	ZB5-AZ009

Operating heads

For use with PXB-B3. and PXB-B4. switch bodies

Spring return pushbuttons

Description	Colour	Metal head		Plastic Head	
		Weight kg	Order code	Weight kg	Order code
 <p>Flush</p>	Black	0,029	ZB4-BA2	0,018	ZB5-AA2
	Green	0,029	ZB4-BA3	0,018	ZB5-AA3
	Red	0,029	ZB4-BA4	0,018	ZB5-AA4
	6 color caps	0,029	ZB4-BA9	0,018	ZB5-AA9
 <p>Projecting</p>	Black	0,030	ZB4-BL2	0,019	ZB5-AL2
	Green	0,030	ZB4-BL3	0,019	ZB5-AL3
	Red	0,030	ZB4-BL4	0,019	ZB5-AL4
 <p>Flush booted</p>	Black	0,034	ZB4-BP2		



Push/push pushbuttons

Description	Colour	Metal head	
		Weight kg	Order code
 <p>Flush</p>	Black	0,029	ZB4-BH02
	Green	0,029	ZB4-BH03
	Red	0,029	ZB4-BH04

Double headed spring return pushbuttons

Description	Colour Marking	Metal head	
		Weight kg	Order code
 <p>Flush</p>	Green/Red I/O	0,047	ZB4-BA8234

Mushroom head pushbuttons

Description	Function	Colour	Metal head		Plastic Head	
			Weight kg	Order code	Weight kg	Order code
 <p>Ø40 mm Mushroom head</p>	Spring return	Black	0,074	ZB4-BC2		
		Green	0,074	ZB4-BC3		
		Red	0,074	ZB4-BC4		
	Latching push-pull	Red	0,077	ZB4-BT4		
 <p>Ø60 mm Mushroom head</p>	Spring return	Black	0,093	ZB4-BR2		
 <p>Ø40 mm Mushroom head</p>	Latching Turn to release	Red	0,070	ZB4-BS54	0,044	ZB5-AS54
	Latching Release by Ronis key N°455	Red	0,070	ZB4-BS14		

Selector switches

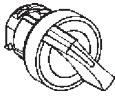
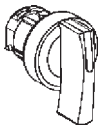
	Description	Function	Metal head		Plastic Head	
			Weight kg	Order code	Weight kg	Order code
	Standard, black handle	2 positions Stay put	0,044	ZB4-BD2	0,024	ZB5-AD2
		3 positions Stay put	0,044	ZB4-BD3	0,024	ZB5-AD3
		3 spring return to centre	0,044	ZB4-BD5	0,024	ZB5-AD5
	Long black handle	2 positions Stay put	0,045	ZB4-BJ2		
		3 positions Stay put	0,045	ZB4-BJ3		
		Spring return to centre	0,045	ZB4-BJ5		
		1 spring return from left to centre	0,045	ZB4-BJ7		

	Description	Function	Key withdrawal	Weight kg	Order code
	Key operated (Ronis key N° 455)	2 stay put positions	Left	0,069	ZB4-BG2
			Left and right	0,069	ZB4-BG4

Tools

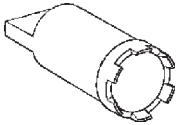
	Description	Weight kg	Order code
	ZB5 head nut tools	0,160	ZB5-AZ905

PXB-B3

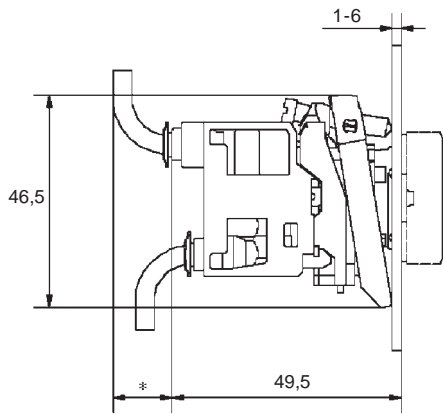

Body width 30 mm
 * With 2 x 4 mm tube = 10
 With 2,7 x 4 mm tube = 15

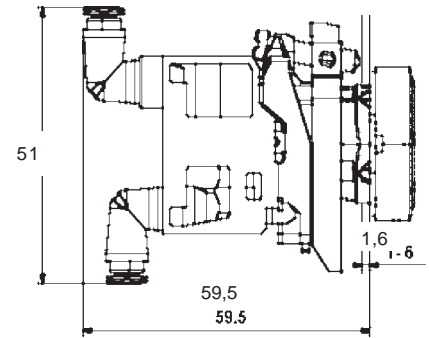
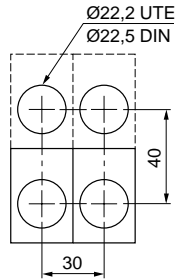

PXB-B4

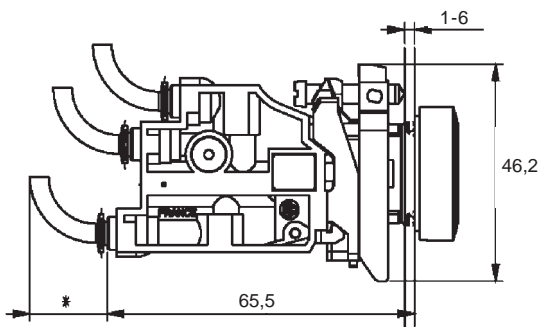

Body width 30 mm
 * With 2 x 4 mm tube = 10
 With 2,7 x 4 mm tube = 15

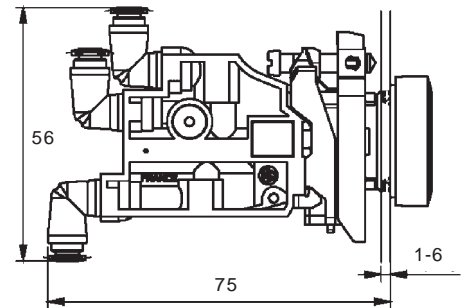

Assembling of PXB-B3. and PXB-B4. valves on mounting block

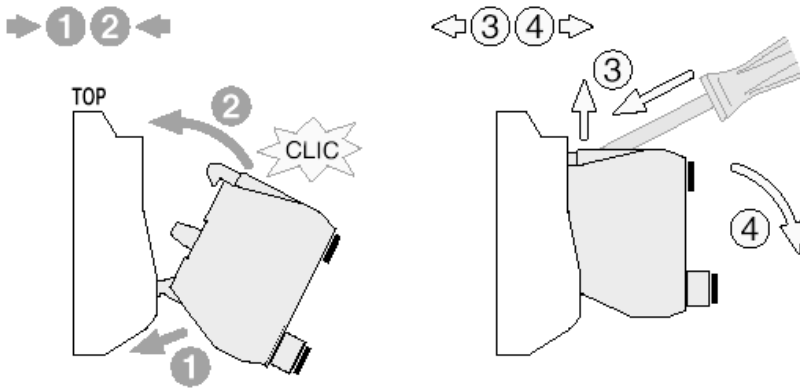

Assembling of PXB-B3. and PXB-B4. valves on the back of the electrical contact

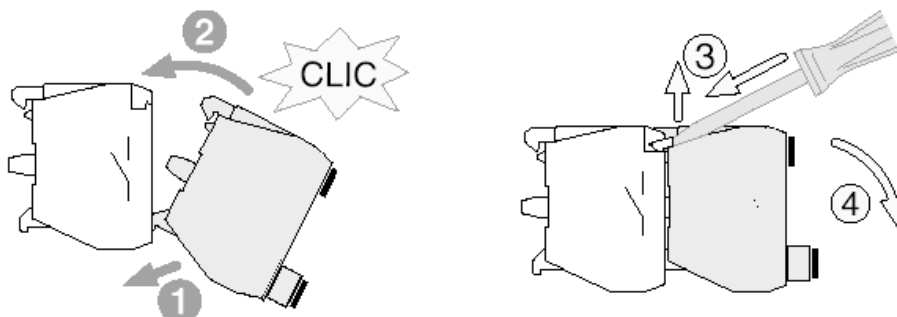

- Lightning fast response
- Simple long life mechanism
- Very high contrast
- All around visibility
- One single pipe connection
- Effective aid to diagnostics

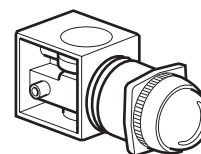

Operating information

Working pressure 1-8 bar
 Working temperature -15 °C to +60 °C

Options and additional information

Connections Ø4 mm straight Push-in
 as standard

Order key

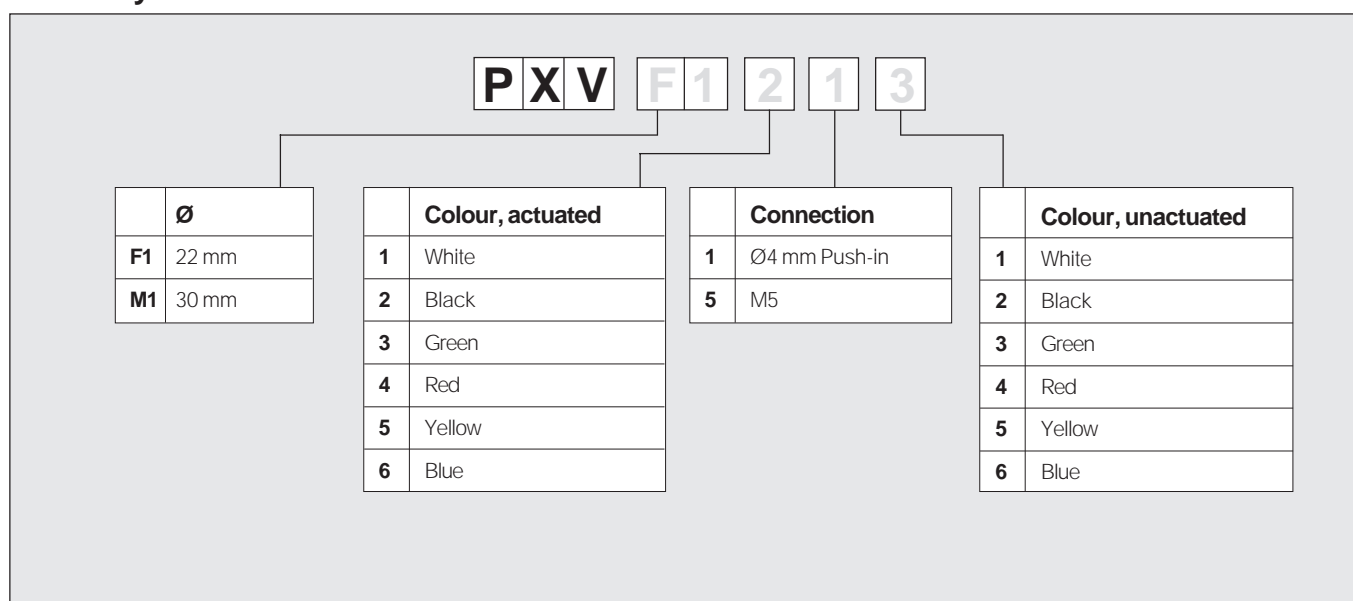

Ø22 mm Visual Indicators

Black plastic bezel
In the actuated mode

Symbol	Colour *	Weight kg	Order code
	Green	0,080	PXV-F131
	Red	0,080	PXV-F141
	Yellow	0,080	PXV-F151
	Blue	0,080	PXV-F161
	White	0,080	PXV-F111

Ø22 mm Visual Indicators

Black plastic bezel
In the unactuated mode

Symbol	Colour *	Weight kg	Order code
	Green	0,080	PXV-F1213
	Red	0,080	PXV-F1214
	Yellow	0,080	PXV-F1215
	Blue	0,080	PXV-F1216
	White	0,080	PXV-F1211

* The pneumatic indicators are black in one position and coloured in the other.
The coloured position corresponds either to the presence of pressure (actuated mode) or the absence of pressure (unactuated mode). For two different colours on the same indicator, please consult Technical Sales Department

Ø22 mm visual indicators

PXV-F1**

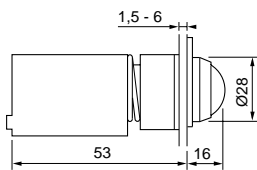

Minimum distance between centres

