

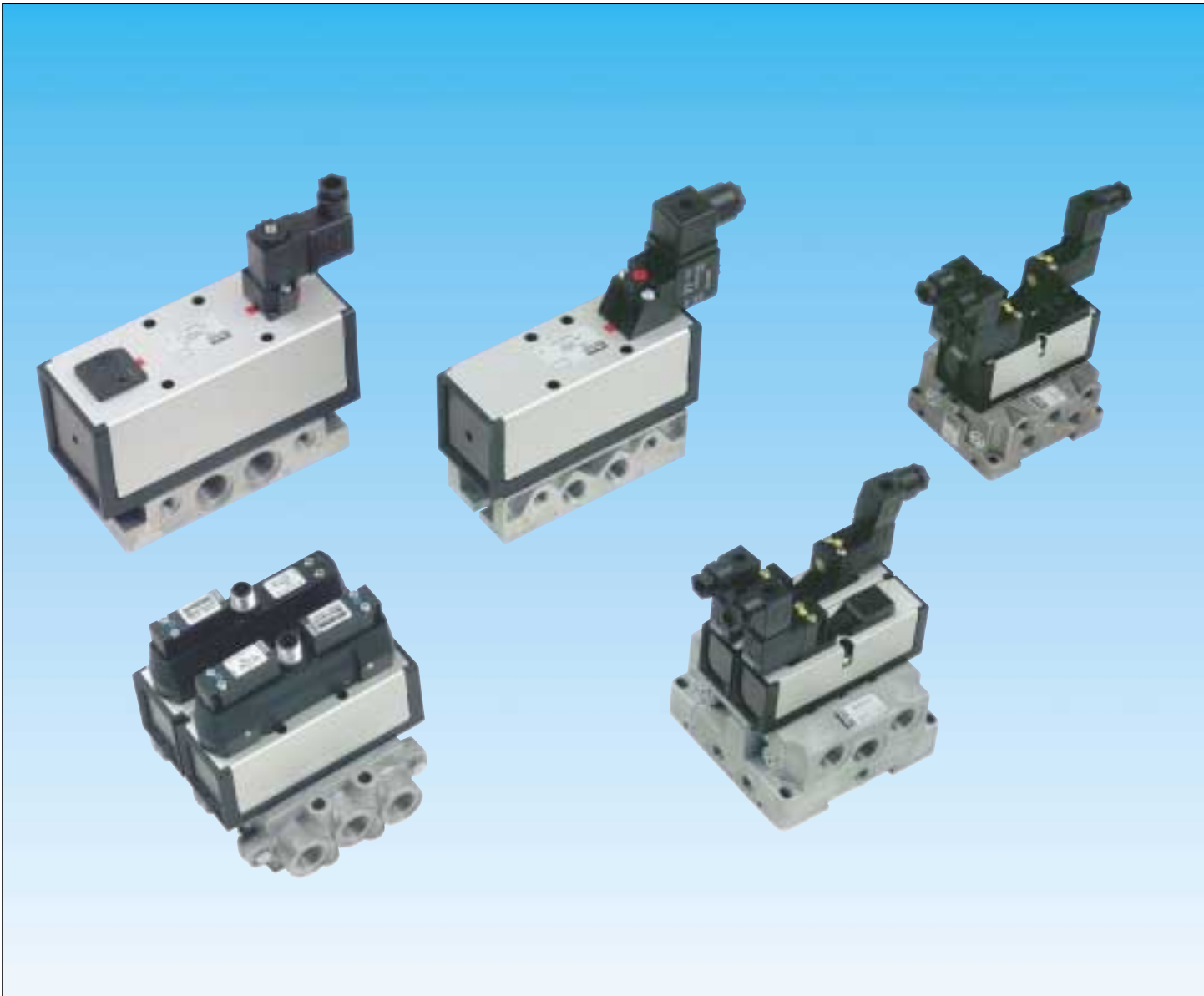

ISOMAX Directional control valves

**According to ISO 5599-1 and
ISO15407-1 (VDMA 24563)**

Catalogue PD0C00025UK01-ev





WARNING

FAILURE OR IMPROPER SELECTION OR IMPROPER USE OF THE PRODUCTS AND/OR SYSTEMS DESCRIBED HEREIN OR RELATED ITEMS CAN CAUSE DEATH, PERSONAL INJURY AND PROPERTY DAMAGE.

This document and other information from Parker Hannifin Corporation, its subsidiaries and authorized distributors provide product and/or system options for further investigation by users having technical expertise. It is important that you analyze all aspects of your application and review the information concerning the product or system in the current product catalog. Due to the variety of operating conditions and applications for these products or systems, the user, through its own analysis and testing, is solely responsible for making the final selection of the products and systems and assuring that all performance, safety and warning requirements of the application are met. The products described herein, including without limitation, product features, specifications, designs, availability and pricing, are subject to change by Parker Hannifin Corporation and its subsidiaries at any time without notice.

SALE CONDITIONS

The items described in this document are available for sale by Parker Hannifin Corporation, its subsidiaries or its authorized distributors. Any sale contract entered into by Parker will be governed by the provisions stated in Parker's standard terms and conditions of sale (copy available upon request).

contents

ISO valves sizes 01 to 3 features.....4 - 5

ISO 15407-1 valves sizes 01 and 02

Technical information.....6
Valve order codes.....7
Solenoid order codes.....8
Base and manifold order codes9
Dimensions.....10 - 11

ISO 5599-1 valves sizes 1 to 3

Standard valves technical information.....12
Standard valves order codes.....13 - 14
Solenoid order codes.....15
LOGISO interfaces.....16
Standard valves dimensions.....17
Valves with M12 connector generalities18
Valves with M12 connector order codes19
Valves with M12 connector dimensions19
Base and manifold order codes.....20
Base and manifold accessories.....21
Base and manifold dimensions.....22 - 23

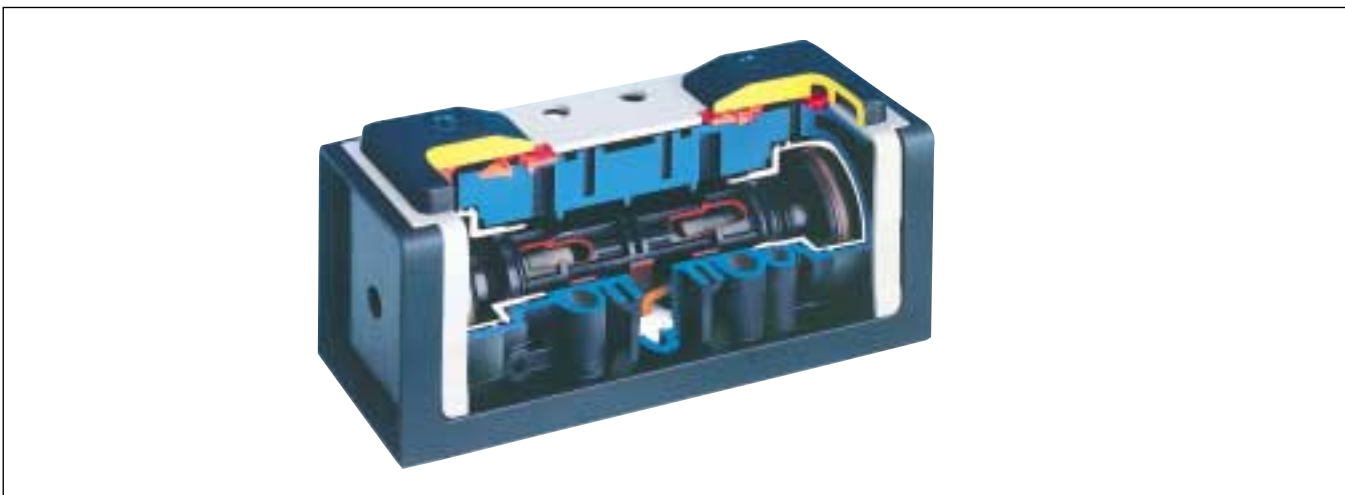

Valve range

DX02 1/8", ISO 15407-1, size 02

DX01 1/4", ISO 15407-1, size 01

DX1 1/4", ISO 5599-1, size 1

DX2 3/8", ISO 5599-1, size 2

DX3 1/2", ISO 5599-1, size 3

The Isomax range of directional control valves, comply with ISO 15407-1 sizes 02 and 01 and ISO5599-1 sizes 1, 2 and 3 and provide flows from 720 NI/min to 6500NI/min.

The range includes both 5/2 and 5/3 valves, for pneumatic and electrical actuation with a wide choice of subbases and manifolds to suit different application needs.



ISO 5599 - 1



ISO 15407 - 1

Ceramic technology

All ISOMAX products use high-tech ceramic switching technology :

- **Excellent reliability :**

Long life in excess of 100 million operations*.

Operates with lubricated or non lubricated air.

Low sensitivity to air quality changes ; switching without seal.

Stiction free.

- **High performances :**

Slide valve concept allows high flow / size ratio and short response time due to short slide stroke and low friction.

- **Stable long lasting performances**

Low friction switching : minimum wear of the valve member/seal assembly.

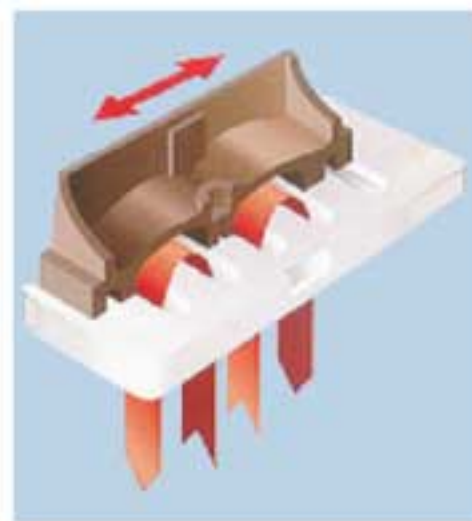

* Refer to our warranty conditions.

Corrosion free and modern design

With the valve body in Polyamide reinforced fibreglass and the casing in anodised aluminium, the complete Isomax range presents a coherent modern design to suit most industrial environments.

Vacuum operation

All Isomax valves may be used for either vacuum or pressure applications.

Air supplied from exhaust ports

In order to supply 2 different pressures to the same actuator, it is possible to connect 2 main pressure supplies to the exhaust ports and use the port 1 as exhaust port.

Central M12 electrical connector versions

All sizes of ISO 5599-1 valves are supplied in a new version with central M12 connector.

Logic elements integrated on valve piloting

Special interfaces for ISOMAX ISO 5599-1 valves are available for direct mounting of logic elements on valve piloting system. This feature allows the creation of complex pilot functions whilst simplifying and reducing piping costs.

Auxiliary manual pilot in option

Manual overrides are supplied as standard on solenoids. An auxiliary manual pilot acting directly on the spool is available as standard on all ISO 5599-1 versions.





General characteristics :

Standard subbase :	ISO 15407-1 and VDMA 24563
Permissible fluid :	Air or inert gas, filtered 40 µ (classe 5 according to ISO 8573-1), lubricated or non-lubricated
Piloting pressure :	2 to 10 bar
Operating pressure :	-0,9 to 10 bar (for pressure under 2 bar, external pilot supply has to be connected)
Supply from exhaust :	Possible
Flow (Qmax) :	DX01 = 1050 Nl/mn - DX02 = 720 Nl/mn
Working temperatures :	-10 to + 60°C (dry air)
Storage temperatures :	-20 to + 70°C
Mechanical life :	> 100 millions operations (dry air filtered 40 µ, 2 Hz, 6 bar, 20°C)
Actuation type :	Pneumatically or electrically with 15 mm solenoid valve interface CNOMO E06.36120N













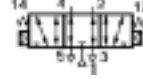

Material specification :

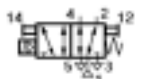
Valve member - seat :	Self lubricating acetal - ceramic
Body :	Polyamide reinforced fibreglass
Casing - End plates :	Anodised aluminium - Painted zinc plated steel
Valve plate :	Zamak
Seals :	Nitrile
Springs :	Stainless steel
Screws :	Zinc plated steel
Function selector : Top cover - Seal :	Polyamide reinforced fiberglass - Polyester

Order key











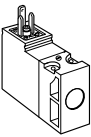
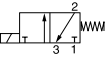









Size	02 18 mm (ISO 15407) 01 26 mm (ISO 15407)	Pilot	4 Pneumatic 6 Electro-pneumatic	Manual override	0 Without any 1 Flush non locking 3 Flush locking 2 Flush non locking (extended 15 mm) 5 Flush locking (extended, 15 mm)	Voltage	B 12 V AC C 24 V AC D 48 V AC J 110 V AC A 230 V AC L 12 V DC M 24 V DC N 48 V DC	Connector	Without any C Standard connector S Connector with LED and protection S3 Connector with LED and protection - 3 m cable S5 Connector with LED and protection - 5 m cable																																																												
<div style="display: flex; justify-content: center; gap: 10px; align-items: center;"> DX 01 - 6 21 - 95 1 M S </div>																																																																					
Function	<table border="1" style="width: 100%; border-collapse: collapse; text-align: center;"> <thead> <tr> <th rowspan="2">pneumatic or electro-pneu int. supply</th> <th colspan="4">electro-pneumatic</th> <th colspan="2">pneumatic and electro-pneu solenoid on 14</th> </tr> <tr> <th>ext. supply</th> <th>int. supply 12 ext. supply 14</th> <th>ext. supply 14 common</th> <th>captured pilot exhaust</th> <th>ext. suply 12 int. supply 14</th> <th>int. supply 12 ext. supply 14</th> </tr> </thead> <tbody> <tr> <td>captured pilot exhaust</td> <td>vented pilot exhaust</td> <td>vented pilot exhaust</td> <td>vented pilot exhaust</td> <td>vented pilot exhaust</td> <td>vented pilot exhaust</td> <td>vented pilot exhaust</td> </tr> <tr> <td>5/2 bistable</td> <td>06</td> <td>08</td> <td>07</td> <td>05</td> <td>31</td> <td>33</td> </tr> <tr> <td>5/2 bistable, 14 prioritised</td> <td>56</td> <td>58</td> <td>57</td> <td>59</td> <td></td> <td></td> </tr> <tr> <td>5/2 monostable, spring return</td> <td>21</td> <td>22</td> <td></td> <td>23</td> <td></td> <td></td> </tr> <tr> <td>5/2 monostable, differential return</td> <td>51</td> <td>53</td> <td>52</td> <td>54</td> <td></td> <td></td> </tr> <tr> <td>5/3 pressure vented centre</td> <td>11</td> <td>12</td> <td>10</td> <td>09</td> <td></td> <td></td> </tr> <tr> <td>5/3 pressure closed centre</td> <td>16</td> <td>18</td> <td>17</td> <td>19</td> <td></td> <td></td> </tr> </tbody> </table>					pneumatic or electro-pneu int. supply	electro-pneumatic				pneumatic and electro-pneu solenoid on 14		ext. supply	int. supply 12 ext. supply 14	ext. supply 14 common	captured pilot exhaust	ext. suply 12 int. supply 14	int. supply 12 ext. supply 14	captured pilot exhaust	vented pilot exhaust	vented pilot exhaust	vented pilot exhaust	vented pilot exhaust	vented pilot exhaust	vented pilot exhaust	5/2 bistable	06	08	07	05	31	33	5/2 bistable, 14 prioritised	56	58	57	59			5/2 monostable, spring return	21	22		23			5/2 monostable, differential return	51	53	52	54			5/3 pressure vented centre	11	12	10	09			5/3 pressure closed centre	16	18	17	19			Electrical operator	60 Without any 95 15 mm solenoid 1,2 W DIN 43650 form C
pneumatic or electro-pneu int. supply	electro-pneumatic				pneumatic and electro-pneu solenoid on 14																																																																
	ext. supply	int. supply 12 ext. supply 14	ext. supply 14 common	captured pilot exhaust	ext. suply 12 int. supply 14	int. supply 12 ext. supply 14																																																															
captured pilot exhaust	vented pilot exhaust	vented pilot exhaust	vented pilot exhaust	vented pilot exhaust	vented pilot exhaust	vented pilot exhaust																																																															
5/2 bistable	06	08	07	05	31	33																																																															
5/2 bistable, 14 prioritised	56	58	57	59																																																																	
5/2 monostable, spring return	21	22		23																																																																	
5/2 monostable, differential return	51	53	52	54																																																																	
5/3 pressure vented centre	11	12	10	09																																																																	
5/3 pressure closed centre	16	18	17	19																																																																	
 = product available on special request																																																																					





Order codes

Symbol	Function	ISO 15407-1 Size	Order code	Weight kg
	5/2 Bistable	02	DX02-406-60	0,09
		01	DX01-406-60	0,13
	5/2 Monostable differential	02	DX02-451-60	0,09
		01	DX01-451-60	0,13
	5/2 Monostable Spring	02	DX02-421-60	0,09
		01	DX01-421-60	0,13
	5/3 closed centre	02	DX02-416-60	0,09
		01	DX01-416-60	0,13
	5/3 vented centre	02	DX02-411-60	0,09
		01	DX01-411-60	0,13
Electrically actuated valves supplied without solenoid - refer to page 8 to select P2E..... solenoid ;				
	5/2 Bistable	02	DX02-606-60	0,09
		01	DX01-606-60	0,13
	5/2 Monostable differential	02	DX02-651-60	0,09
		01	DX01-651-60	0,13
	5/2 Monostable Spring	02	DX02-621-60	0,09
		01	DX01-621-60	0,13
	5/3 closed centre	02	DX02-616-60	0,09
		01	DX01-616-60	0,13
	5/3 vented centre	02	DX02-611-60	0,09
		01	DX01-611-60	0,13
Electrically actuated valves supplied with solenoid 24 V DC - For other voltage or manual override type refer to ordering key page 6				
	5/2 Bistable	02	DX02-606-951M*	0,17
		01	DX01-606-951M*	0,21
	5/2 Monostable differential	02	DX02-651-951M*	0,13
		01	DX01-651-951M*	0,17
	5/2 Monostable Spring	02	DX02-621-951M*	0,13
		01	DX01-621-951M*	0,17
	5/3 closed centre	02	DX02-616-951M*	0,17
		01	DX01-616-951M*	0,21
	5/3 vented centre	02	DX02-611-951M*	0,17
		01	DX01-611-951M*	0,21

* With non-locking manual override; to obtain the same valve with locking manual override, replace 951M by 953M in the order code.

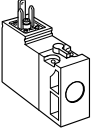
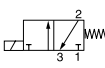
Solenoids 15 mm NC, standard







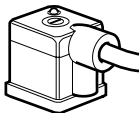

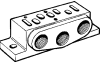

	Voltage	Weight kg	Order code Without manual override		Weight kg	Order code Override, blue, non locking flush		Weight kg	Order code Override, yellow locking flush
 	12 V DC	0,038	P2E-KV32B0 		0,038	P2E-KV32B1 		0,038	P2E-KV32B2 
	24 V DC	0,038	P2E-KV32C0 		0,038	P2E-KV32C1 		0,038	P2E-KV32C2 
	48 V DC	0,038	P2E-KV32D0 		0,038	P2E-KV32D1 		0,038	P2E-KV32D2 
	24 V AC 50Hz	0,038	P2E-KV31C0 		0,038	P2E-KV31C1 		0,038	P2E-KV31C2 
	48 V AC 50/60Hz	0,038	P2E-KV34D0 		0,038	P2E-KV34D1 		0,038	P2E-KV34D2 
	115 V AC 50Hz/ 120 V AC 60Hz	0,038	P2E-KV31F0		0,038	P2E-KV31F1 		0,038	P2E-KV31F2 
	230 V AC 50Hz/ 240 V AC 60Hz	0,038	P2E-KV31J0		0,038	P2E-KV31J1 		0,038	P2E-KV31J2 

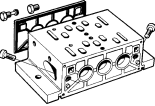
	Voltage	Weight kg	Order code Override extended, blue, non locking		Weight kg	Order code Override extended, yellow, locking
 	24 V DC	0,038	P2E-KV32C3 		0,038	P2E-KV32C4 
	24 V AC 50Hz	0,038	P2E-KV31C3 		0,038	P2E-KV31C4 

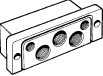
Cable plugs DIN 43650, form C

	Description	Weight kg	Order code		
	With standard screw		Standard IP 65	0,02	P8C-D
			24 V DC VDR + LED IP65	0,02	P8C-D26C
			110 V AC VDR + LED IP65	0,02	P8C-D21E
	With cable		Standard with 2 m cable - IP65	0,13	P8L-C2
			Standard with 5 m cable - IP65	0,30	P8L-C5
			24 V AC/DC, 2 m cable VDR + LED IP65	0,13	P8L-C226C
			24 V AC/DC, 5 m cable VDR + LED IP65	0,30	P8L-C526C
			24 V AC/DC, 10 m cable VDR + LED IP65	0,58	P8L-CA26C
			110 V AC/DC, 2 m cable VDR + LED IP65	0,13	P8L-C221E
			110 V AC/DC, 5 m cable VDR + LED IP65	0,30	P8L-C521E

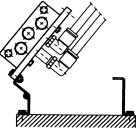
Bases and manifolds

	Description	Order code	Weight kg	Port size
	Subbase with side ports			
	Size 02	PL02-01-70	0,07	G1/8
	Size 01	P2V-BS512SS	0,12	G1/4
	Subbase with bottom ports			
	Size 01	P2V-BS511SB	0,07	G1/8
	Manifold with 2 valve positions with side ports			
	Size 02	PJLP02-201-70*	0,14	G1/8
	Size 01	PJL01-201-70	0,73	G1/8
	Size 01	PJL01-202-70	0,73	G1/4
	End plate kit for side ported manifold with 2 valve positions			
	Size 02	PEJ02-02-70	0,15	G1/4
	Size 01	PEJ01-03-70	0,52	G3/8
	Intermediate supply block (to fit in place of a valve on manifold)			
	Size 02	D02P-01-70	0,08	G1/8
	Size 01	D01P-02-70	0,10	G1/4
	Set of blanking cap (fit between 2 manifolds PJL)			
	Size 02	D02BD0	0,01	
	Size 01	D01BD0	0,02	
	Bottom ported manifold with 2 valves positions			
	Size 02	P2V-AM511PB	0,20	G1/8
	Size 01	P2V-BM512PB	0,40	G1/4
 	G side end plate bottom ported for above ported manifold			
	Size 02 (G side)	P2V-AM512GB	0,18	G1/4
	Size 01 (G side)	P2V-BM513GB	0,22	G3/8
 	H side end plate bottom ported for above ported manifold			
	Size 02 (H side)	P2V-AM512HB	0,18	G1/4
	Size 01 (H side)	P2V-BM513HB	0,22	G3/8
	Transfer plate for manifold 2 valves positions with bottom ports size 01 to size 02			
	Size 01 → 02	P2V-AM500BE	0,33	
	Set of blanking caps (fit between 2 manifolds P2V-*M)			
	Size 02	P2V-AK0P	0,01	
	Size 01	P2V-BK0P	0,01	
	Angle mounting set for manifold 2 valve positions with bottom ports (P2V-*M)			
	Size 01 or 02	P2V-AK0M	0,14	
	Blanking plate (for one valve position)			
	Size 02	DX02BLK	0,04	
	Size 01	DX01BLK	0,05	

* Note : manifold PJLP-02-201-70 does not include individual connection ports 12 and 14 ; for pneumatic actuated valves, you need to mount air pilot connectors (reference PVA-P111) in place of the solenoids directly on the valve to give air pilot function.

Dimensions

DX01 and DX02 valves

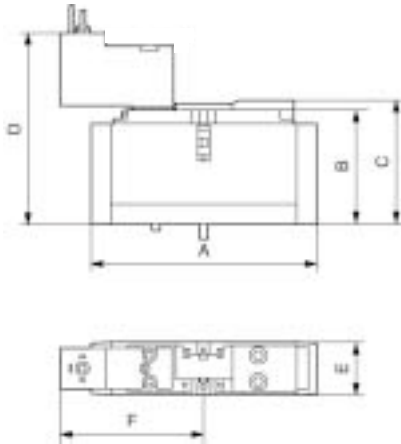

	A	B	C	D	E	F
DX02	80	41	44,5	67,8	18	51,2
DX01	100	42	45,5	68,8	26	51,2

Single subbases side ported

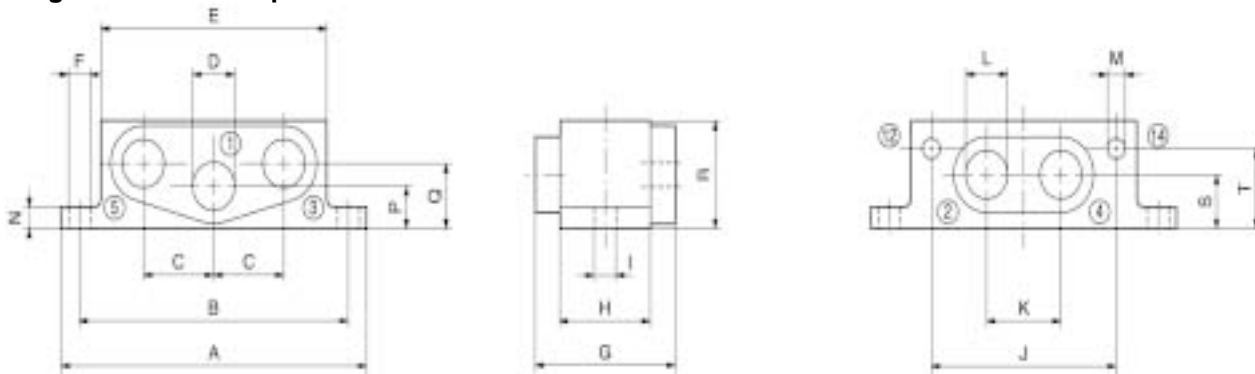

	Size	A	B	C	D	E	F	G	H	I	J	K	L	M	N	P	Q	R	S	T
PL02-01-70	02	80	70	16	G1/8	52	8	27	19	5,5	40	17	G1/8	M5	8	8	8	22	13	6
P2V-BS512SS	01	92	80	21,2	G1/8	68	6,5	42	27	5,5	55	22	G1/8	M5	6	11	17	28	14	21

Side ported manifolds for 2 valve positions

	Size	A	B	C	D	E	F	G	H
PJLP02-201-70	02	38,5	80	12	Ø 4,2	38	14	18	72
PJL01-201-70	01	55	100	24	Ø 5,5	54	17	22	90
PJL01-202-70									

Bottom ported manifolds for 2 valve positions

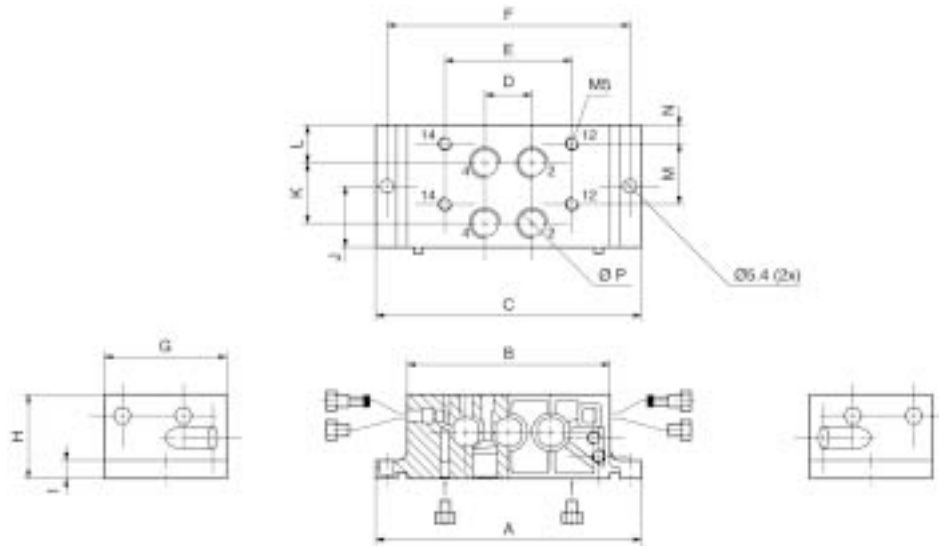

	Size	A	B	C	D	E	F	G	H	I	J	K	L	M	N	P
P2V-AM511PB	02	102	74	74,6	16	43	92	38	26	7	19	19	11	19	5	G1/8
P2V-BM512PB	01	118	90	90,6	21	56,5	108	54	37	8	27	27	16,5	27	8	G1/4

G and H side end plate bottom ported for above bottom ported manifold

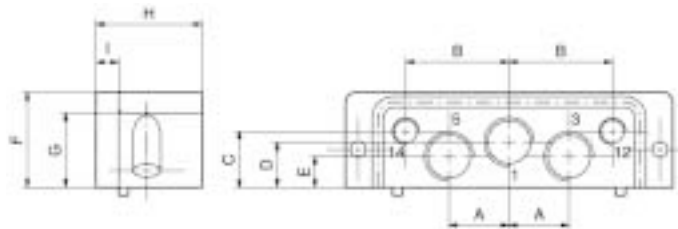

	Size	Port size 1,2,3	Port size 12, 14	A	B	C	D	E	F	G	H	I
P2V-AM512GB and P2V-AM512HB	02	G1/4	G1/8	17	29	21	18,5	9,5	35,5	28	33	7
P2V-BM513GB and P2V-BM513HB	01	G3/8	G1/8	21,5	37	20	16	11	34,5	28	38	8

Transfer plate size 01 to size 02 for above bottom ported manifold

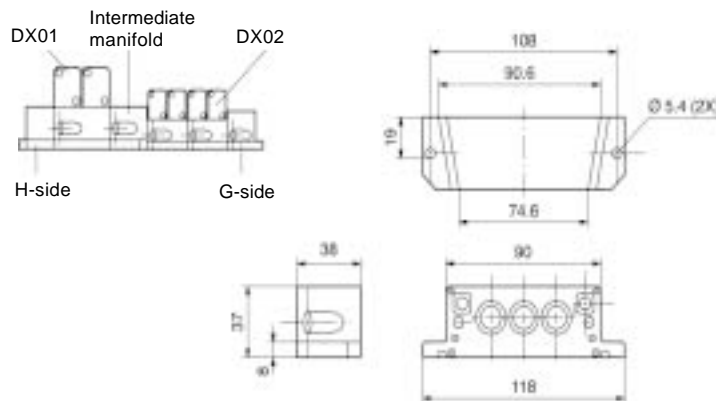

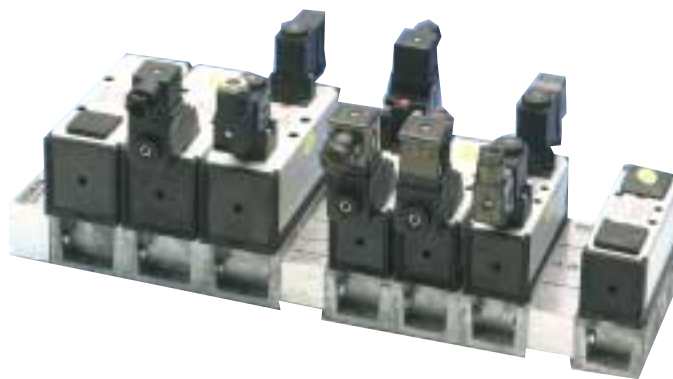

General characteristics :

Standard subbase : ISO 5599-1 and NFE 49-080
 Permissible fluid : Air or inert gas, filtered 40 µ (classe 5 according to ISO 8573-1), lubricated or non-lubricated
 Piloting pressure : 2 to 12 bar (2 to 10 bar with 15 mm solenoid)
 Operating pressure : -0,9 to 12 bar (for pressure under 2 bar, external pilot supply has to be connected)
 Supply from exhaust : Possible
 Flow (Qmax) : DX1 = 1680 NI/mn - DX2 = 4320 NI/mn - DX3 = 6540 NI/mn
 Working temperatures : -10 to + 60°C (dry air)
 Storage temperatures : -20 to + 80°C (-20 to + 70°C with 15 mm solenoids)
 Mechanical life : > 100 millions operations (dry air filtered 40 µ, 2 Hz, 6 bar, 20°C)
 Actuation type : Pneumatically or electrically with CNOMO 06-05-10 solenoids 30 mm or 22 mm or with 15 mm solenoid valve interface CNOMO E06.36120N.

Material specification :

Valve member - seat : Self lubricating acetal - ceramic
 Body : Polyamide reinforced fibreglass
 Casing - End plates : Anodised aluminium - Painted zinc plated steel
 Valve plate : Zamak
 Seals : Nitrile
 Springs : Stainless steel
 Screws : Zinc plated steel
 Function selector : Top cover - Seal : Polyamide reinforced fiberglass - Polyester

Ordering key

Execution	Size	Pilot	Manual override	Voltage	Connector
Standard	1 Size 1 (ISO 5599)	4 Pneumatic	0 Without any	B 12 V AC	Without any
D Anti-corrosion	2 Size 2 (ISO 5599)	6 Electro-pneumatic	1 Flush non locking	C 24 V AC	C Standard connector
	3 Size 3 (ISO 5599)		3 Flush locking	D 48 V AC	S Connector with LED and protection
				J 110 V AC	S3 Connector with LED and protection - 3 m cable
				A 230 V AC	S5 Connector with LED and protection - 5 m cable
				L 12 V DC	
				M 24 V DC	
				N 48 V DC	

DX

1
-
6
21
-
76
1
M
S

Function	pneumatic or electro-pneu		electro-pneumatic		pneumatic and electro-pneu	
	int. supply	ext. supply	int. supply 12 ext. supply 14	int. supply 12 ext. supply 14	solenoid on 14	solenoid on 12
	captured pilot exhaust	vented pilot exhaust	vented pilot exhaust	vented pilot exhaust	vented pilot exhaust	vented pilot exhaust
5/2 bistable	06	08	07	31	33	
5/2 bistable, 14 prioritised	56	58				
5/2 monostable, spring return	21	22				
5/2 monostable, differential return	51	53	52			
5/3 pressure vented centre	11	12	10			
5/3 pressure closed centre	16	18	17			
5/3 pressurised centre	13	24	15			

Electrical operator, auxiliary manual pilot		
	electrical operator	aux. manual. pilot
60	Without any	No
61	EV 310	
66	EV 30 - 6,5 W	
67	EV 30 - 3 W	
6A	15 mm solenoid, individual plate, pin up	
6B	15 mm solenoid, individual plate, pin up (high flow)	
70	Without any	Yes
71	EV 310	
76	EV 30 - 6,5 W	
77	EV 30 - 3 W	
7A	15 mm solenoid, individual plate, pin up	
7B	15 mm solenoid, individual plate, pin up (high flow)	

 = product available on special request

Order codes

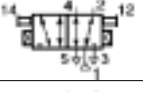
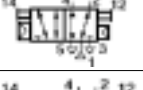
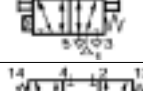
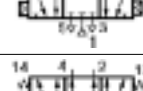
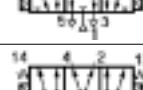
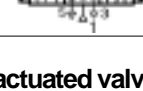

Pneumatically actuated valves

Symbol	Function	ISO 5599-1 size	Order code	Weight kg
	5/2 Bistable	1	DX1-406-70	0,35
		2	DX2-406-70	0,60
		3	DX3-406-70	1,10
	5/2 Monostable differential	1	DX1-451-70	0,35
		2	DX2-451-70	0,60
		3	DX3-451-70	1,10
	5/2 Monostable spring	1	DX1-421-70	0,35
		2	DX2-421-70	0,60
		3	DX3-421-70	1,10
	5/3 closed centre	1	DX1-416-70	0,35
		2	DX2-416-70	0,60
		3	DX3-416-70	1,10
	5/3 vented centre	1	DX1-411-70	0,35
		2	DX2-411-70	0,60
		3	DX3-411-70	1,10
	5/3 pressurised centre	1	DX1-413-70	0,35
		2	DX2-413-70	0,60

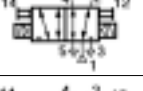
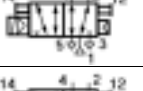
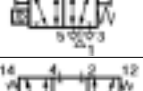
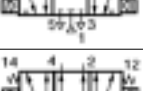
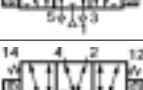
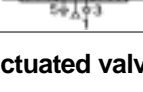
Electrically actuated valves for CNOMO 06-05-10 solenoid supplied without solenoid - Refer to page 15 to select solenoid

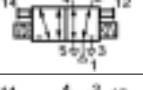
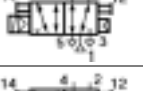
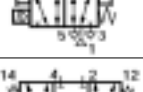
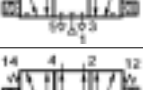
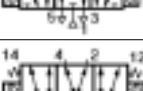

	Bistable	1	DX1-606-70	0,35
		2	DX2-606-70	0,60
		3	DX3-606-70	1,10
	5/2 Monostable differential	1	DX1-651-70	0,35
		2	DX2-651-70	0,60
		3	DX3-651-70	1,10
	5/2 Monostable spring	1	DX1-621-70	0,35
		2	DX2-621-70	0,60
		3	DX3-621-70	1,10
	5/3 closed centre	1	DX1-616-70	0,65
		2	DX2-616-70	0,60
		3	DX3-616-70	1,10
	5/3 vented centre	1	DX1-611-70	0,35
		2	DX2-611-70	0,60
		3	DX3-611-70	1,10
	5/3 pressurised centre	1	DX1-613-70	0,35
		2	DX2-613-70	0,60

Electrically actuated valves for 15 mm solenoid supplied without solenoid - Refer to page 15 to select solenoid

	Bistable	1	DX1-606-7B	0,37
		2	DX2-606-7B	0,60
		3	DX3-606-7B	1,10
	5/2 Monostable differential	1	DX1-651-7B	0,36
		2	DX2-651-7B	0,60
		3	DX3-651-7B	1,10
	5/2 Monostable spring	1	DX1-621-7B	0,36
		2	DX2-621-7B	0,60
		3	DX3-621-7B	1,10
	5/3 closed centre	1	DX1-616-7B	0,37
		2	DX2-616-7B	0,60
		3	DX3-616-7B	1,10
	5/3 vented centre	1	DX1-611-7B	0,37
		2	DX2-611-7B	0,60
		3	DX3-611-7B	1,10
	5/3 pressurised centre	1	DX1-613-7B	0,37
		2	DX2-613-7B	0,60

Order codes

Electrically actuated valves with CNOMO 06-05-10 30 mm solenoid 24 V DC (supplied without cable plug) ;

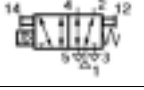
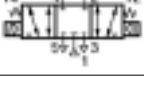
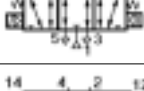
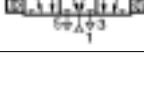



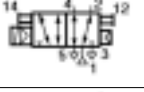
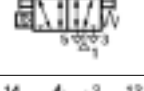
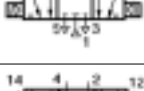
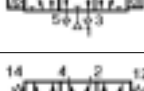
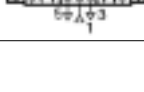



Symbol	Function	ISO 5599-1 size	Order code	Weight kg
	Bistable	1	DX1-606-761M	0,65
		2	DX2-606-761M	0,90
		3	DX3-606-761M	1,40
	5/2 Monostable differential	1	DX1-651-761M	0,50
		2	DX2-651-761M	0,75
		3	DX3-651-761M	1,25
	5/2 Monostable spring	1	DX1-621-761M	0,50
		2	DX2-621-761M	0,75
		3	DX3-621-761M	1,25
	5/3 closed centre	1	DX1-616-761M	0,35
		2	DX2-616-761M	0,90
		3	DX3-616-761M	1,40
	5/3 vented centre	1	DX1-611-761M	0,65
		2	DX2-611-761M	0,90
		3	DX3-611-761M	1,40
	5/3 pressurised centre	1	DX1-613-761M	0,65
		2	DX2-613-761M	0,90

Electrically actuated valves with 15 mm solenoid 24 V DC (supplied without cable plug) ;

Symbol	Function	ISO 5599-1 size	Order code	Weight kg
	Bistable	1	DX1-606-7B1M	0,45
		2	DX2-606-7B1M	0,70
		3	DX3-606-7B1M	1,20
	5/2 Monostable differential	1	DX1-651-7B1M	0,41
		2	DX2-651-7B1M	0,65
		3	DX3-651-7B1M	1,15
	Monostable spring	1	DX1-621-7B1M	0,41
		2	DX2-621-7B1M	0,65
		3	DX3-621-7B1M	1,15
	5/3 closed centre	1	DX1-616-7B1M	0,45
		2	DX2-616-7B1M	0,70
		3	DX3-616-7B1M	1,20
	5/3 vented centre	1	DX1-611-7B1M	0,45
		2	DX2-611-7B1M	0,70
		3	DX3-611-7B1M	1,20
	5/3 pressurised centre	1	DX1-613-7B1M	0,45
		2	DX2-613-7B1M	0,70

Note : all valves proposed in this page are supplied with non-locking manual override on the solenoids ; to obtain the same valves with locking manual override change the last digits of the order coder from 1M to 3M.

Solenoids

		Voltage	Weight kg	Order code Without manual override	Order code Manual override non locking	Order code Manual override locking
EV30-4.5 W DC, 5 VA AC solenoids with CNOMO 06-05-10 interface and for cable plug DIN 43650 form A (supplied without cable plug)						
		24 V DC	0,17	EV30M0100	EV30M1100	EV30M3100
		24 V AC	0,17	EV30C0100	EV30C1100	EV30C3100
		110 V AC	0,17	EV30J0100	EV30J1100	EV30J3100
		230 V DC	0,17	EV30A0100	EV30A1100	EV30A3100
EV30-2.5 W DC, 3 VA AC solenoids with CNOMO 06-05-10 interface and for cable plug DIN 43650 form A (supplied without cable plug)						
		24 V DC	0,17	EV30M0200	EV30M1200	EV30M3200
		24 V AC	0,17	EV30C0200	EV30C1200	EV30C3200
		110 V AC	0,17	EV30J0200	EV30J1200	EV30J3200
		230 V AC	0,17	EV30A0200	EV30A1200	EV30A3200
EV310-2.5 W DC, 4.5 VA AC solenoids with CNOMO 06-05-10 interface and for cable plug DIN 43650 form B (supplied without cable plug)						
		24 V DC	0,17	EV0M310	1EV1M310	EV3M310
		24 V AC	0,17	EV0C310	1EV1C310	EV3C310
		110 V AC	0,17	EV0J310	1EV1J310	EV3J310
		230 V AC	0,17	EV0A310	1EV1A310	EV3A310
15 mm High-flow solenoids 1.8 W DC, 2.4 VA AC for cable plug DIN 43650 form C (supplied without cable plug)						
		24 V DC	0,17	P2E- HV32C0	P2E-HV32C1	P2E-HV32C2
		24 V AC	0,17	P2E-HV31C0	P2E-HV31C1	P2E-HV31C2
		48 V DC	0,17	P2E-HV32D0	P2E-HV32D1	P2E-HV32D2
		115/120 V AC	0,17	P2E-HV31F0	P2E-HV31F1	P2E-HV31F2

Cable plugs

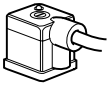
	Description	Order code DIN 43650 form A (for EV30)	Order code DIN 43650 form B (for EV310)	Order code DIN 43650 form C (for 15 mm solenoid)
	- Standard (without flying lead)	3EV290V10	3EV10V10	P8C-D
	- With LED and protection 24 V AC/DC	3EV290V20-24	3EV10V20-24	P8C-D26C
	- With LED and protection 110 V AC	3EV290V20-110	3EV10V20-110	P8C-D21E
	- With LED and protection 230 V AC	3EV290V20-230	3EV10V20-230	-
	- With 5 m flying lead cable LED and protection 24 V AC/DC	3EV290V20-24L5	3EV10V20-24L5	P8L-C526C
	- With 5 m cable - LED and protection 110 V AC	3EV290V20-110L5	3EV10V20-110L5	P8L-C521E
	- With 5 m cable - LED and protection 230 V AC	3EV290V20-230L5	3EV10V20-230L5	-

LOGISO interfaces

Logiso interfaces allow direct mounting of logic elements on Isomax valves sizes 1 to 3 ; it allows to create simple solution on creating complex valve pilot function :
 low pressure or high pressure signal, delayed pilot signal, or control of alternating movement, etc....



Symbol	Function	Order code	Weight kg
--------	----------	------------	-----------

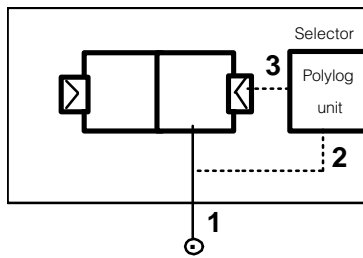

Port 1 (input signal 1 for logic element) is connected to pilot port 12 or 14 valves subbase.

Port 2 (input signal 2 for logic element) is connected to the internal air supply of the valve.

38DX70 0,05

Selector
Polylog
unit

Port 1 (input signal 1 for logic element) is connected to pilot port 12 or 14 valves subbase.

Port 2 (input signal 2)for logic element is connected to the external Ø 4 mm push-in fitting.

34DX70 0,25

Ø 4 mm connector on LOGISO EX

Ø 4 mm connector on LOGISO Tee

Polylog
unit

Use to tee off output (port 3) of the logic unit. Has to be mounted in association with Logiso IN or Logiso Ex interfaces for use with logic elements.

33DX70 0,05

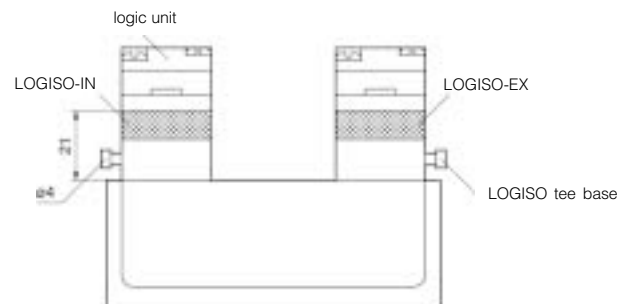
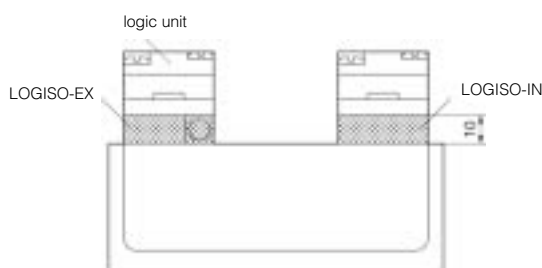

Dimensions

Pneumatically actuated

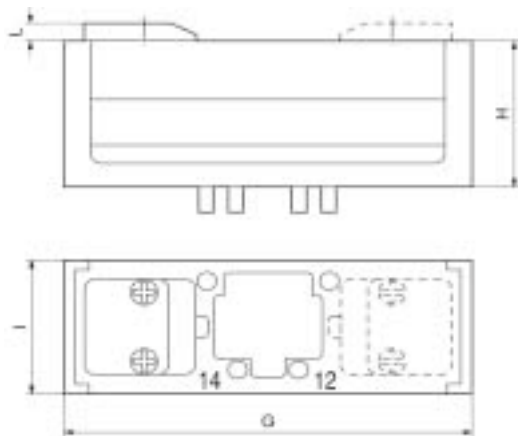

With EV30 solenoids

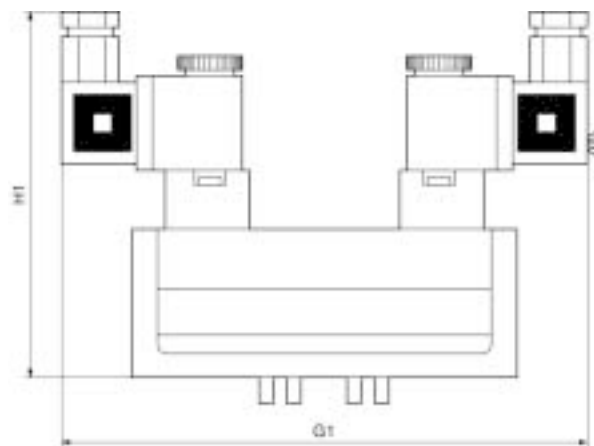

With EV310 solenoids

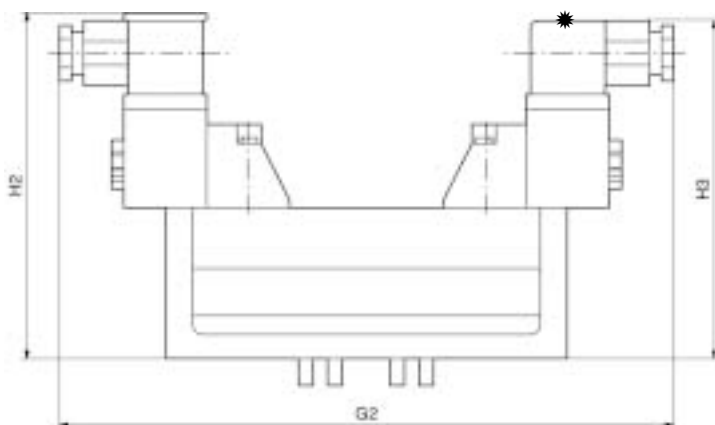

With 15 mm solenoids

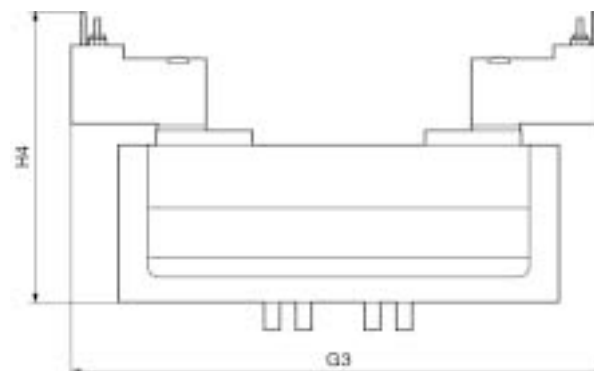

	G	G1	G2	G3	H	H1	H2	H3	H4	I	L
DX1	120	164	202,5	160	47	115	112,5	119	79	42	5
DX2	140	179,5	218	175,5	58,5	126,5	126,5	130	90,5	54	5
DX3	170	198	235,5	194	71	139	139	142,5	103	68	5



General characteristics :

Standard subbase :	ISO 5599-1 and NFE 49-080
Permissible fluid :	Air or inert gas, filtered 40 µ (classe 5 according to ISO 8573-1), lubricated or non-lubricated
Piloting pressure :	2 to 10 bar
Operating pressure :	-0,9 to 10 bar (for pressure under 2 bar, external pilot supply has to be connected)
Supply from exhaust :	Possible
Flow (Qmax) :	DX1 = 1680 NI/mn - DX2 = 4320 NI/mn - DX3 = 6540 NI/mn
Working temperatures :	-10 to + 60°C (dry air)
Storage temperatures :	-20 to + 70°C
Mechanical life :	> 100 millions operations (dry air filtered 40 µ, 2 Hz, 6 bar, 20°C)
Actuation type :	Electrically
Voltage :	24 V DC
Electrical connections :	Central M12 connector (according to norm E03.62.520N) with 4 pins Pin 1 : free Pin 2 : +24 V DC side 12 Pin 3 : 0 V common Pin 4 : + 24 V DC side 14
Dust and water protection :	IP 65 (according to EN 60529)
Pilot power consumption :	1,8 W per pilot
Solenoid actuation indication :	By green LED
Manual override :	Locking or non locking on the solenoids (version without manual override on request)

Material specification :

Valve member - seat :	Self lubricating acetal - ceramic
Body :	Polyamide reinforced fibreglass
Casing - End plates :	Anodised aluminium - Painted zinc plated steel
Valve plate :	Zamak
Seals :	Nitrile
Springs :	Stainless steel
Screws :	Zinc plated steel
Function selector : Top cover - Seal :	Polyamide reinforced fibreglass - Polyester

Ordering key

Execution	Size	Pilot	Manual override	Voltage	Connector
Standard	1 Size 1 (ISO 5599)	6 Electro-pneumatic	0 Without any	M 24 V DC	A M12 connector (5° oriented, 12 side)
D Anti-corrosion	2 Size 2 (ISO 5599)		1 Flush non locking		B M12 connector (22,5° oriented, 14 side)
	3 Size 3 (ISO 5599)		3 Flush locking		
			2 Flush non locking (extended 15 mm)		
			5 Flush locking (extended, 15 mm)		

DX

1
-
6
21
-
96
1
M
B

Function	electro-pneumatic				Electrical operator, auxiliary manual pilot on spool	
	int. supply	ext. supply by 12 and 14	ext. supply by 14	int. supply 12 ext. supply 14	electrical operator	aux. manual. pilot
5/2 bistable	06	08	61	07	15 mm solenoid 1,8 W (high flow)	No
5/2 bistable, 14 prioritised	56	58	62			
5/2 monostable, spring return	21	22				
5/2 monostable, differential return	51	53	63	52		
5/3 pressure vented centre	11	12	64	10		
5/3 pressure closed centre	16	18	65	17		
5/3 pressurised centre	13	14	66	15		

= product available on special request

Order codes

Manual override non-locking ; internal pilot supply

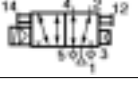
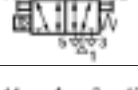
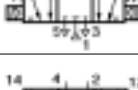
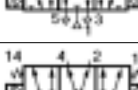
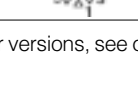
Symbol	Function	ISO 5599-1 Size	Order code	Weight	Order code	Weight
			with M12 5° oriented side 12	kg	with M12 22,5° oriented side 14	kg
	Bistable	1	DX1-606-961MA	0,50	DX1-606-961MB	0,50
		2	DX2-606-961MA	0,74	DX2-606-961MB	0,74
		3	DX3-606-961MA	1,30	DX3-606-961MB	1,30
	5/2 Monostable differential	1	DX1-651-961MA	0,47	DX1-651-961MB	0,47
		2	DX2-651-961MA	0,70	DX2-651-961MB	0,70
		3	DX3-651-961MA	1,25	DX3-651-961MB	1,25
	5/2 Monostable spring	1	DX1-621-961MA	0,47	DX1-621-961MB	0,47
		2	DX2-621-961MA	0,70	DX2-621-961MB	0,70
		3	DX3-621-961MA	1,25	DX3-621-961MB	1,25
	5/3 closed centre	1	DX1-616-961MA	0,50	DX1-616-961MB	0,50
		2	DX2-616-961MA	0,74	DX2-616-961MB	0,74
		3	DX3-616-961MA	1,30	DX3-616-961MB	1,30
	5/3 vented centre	1	DX1-611-961MA	0,50	DX1-611-961MB	0,50
		2	DX2-611-961MA	0,74	DX2-611-961MB	0,74
		3	DX3-611-961MA	1,30	DX3-611-961MB	1,30
	5/3 pressurised centre	1	DX1-613-961MA	0,50	DX1-613-961MB	0,50
		2	DX2-613-961MA	0,74	DX2-613-961MB	0,74

Note : for all other versions, see ordering key page 18

Dimensions

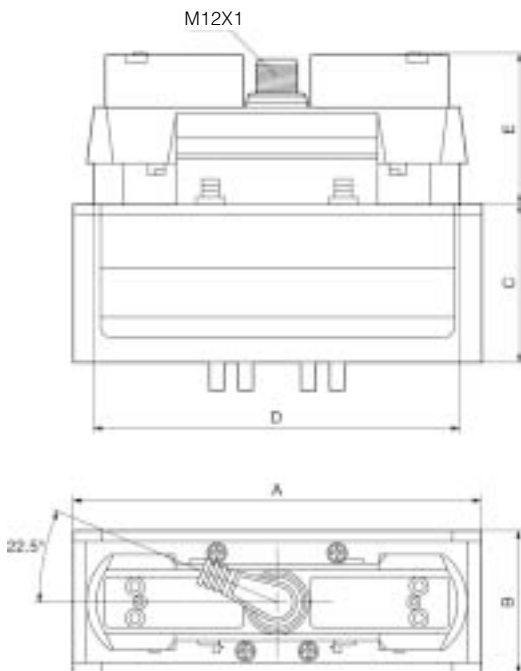





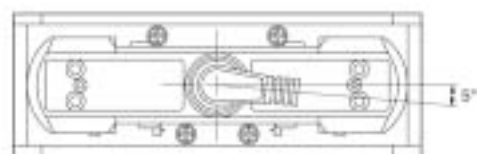

	A	B	C	D	E*
DX1	120	42	47	108	44
DX2	140	54	58,5	114	44
DX3	170	68	71	132	44

* For version with external pilot supply common by 14, add 6 mm.

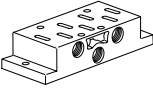









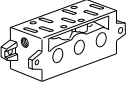

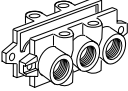
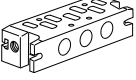

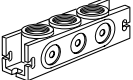
Manifolds and subbases

Single subbases

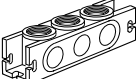
		Description	Order code	Weight kg	Port size
		Subbase with side ports according to VDMA			
		Size 1	P2N-VS512SD	0,16	G1/4
		Size 2	P2N-WS513S	0,28	G3/8
		Size 3	P2N-YS514SD	0,35	G1/2
		Subbase with side ports			
		Size 1	PL1-1/4-70	0,16	G1/4
		Size 2	PL2-3/8-70	0,28	G3/8
		Size 3	P2N-JS516SD	0,57	G3/4
		Subbase with bottom ports			
		Size 1	PD1-1/4-70	0,37	G1/4
		Size 2	PD2-3/8-70	0,59	G3/8
		Size 3	PD3-1/2-70	0,90	G1/2

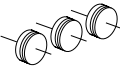
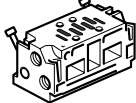
Manifolds

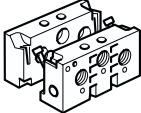
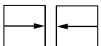
		Description	Order code	Weight kg	Port size
		Manifold with bottom ports according to VDMA			
		Size 1	P2N-VM512MB	0,24	G1/4
		Size 2	P2N-WM513MB	0,36	G3/8
		Size 3	P2N-YM514MB	0,70	G1/2
	End plate kit for above bottom ported manifold according to VDMA				
	Size 1	P2N-VM513E	0,21	G3/8	
	Size 2	P2N-WM514ES	0,36	G1/2	
	Size 3	P2N-YM518ES	0,68	G1	
		Manifold with bottom ports low profile			
		Size 1	P2N-AM512MB	0,20	G1/4
		Top or bottom ported connecting block for above manifold "low profile"			
		Size 1	P2N-AM513GT	0,15	G3/8
		End piece for above manifold "low profile"			
		Size 1	P2N-AM500J	0,06	
		Top or bottom ported intermediate supply for above manifold "low profile"			
		Size 1	P2N-AM513BT	0,14	G3/8
	Isolating seal for above manifold "low profile"				
	Size 1	P2N-AK0P	0,07		
		Manifold with side port			
		Size 1	P2N-EM512MD	0,24	G1/4
		Size 2	P2N-FM513MD	0,36	G3/8
		Side ported connecting kit for above manifold with side ports			
		Size 1	P2N-EM513ES	0,21	G3/8
		Size 2	P2N-FM514ES	0,29	G1/2

Manifolds and subbases accessories

Order codes

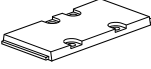
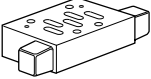
	Description	Order code	Weight kg
	Blanking plate		
	Size 1	P2N-AA5B	0,10
	Size 2	P2N-BA5B	0,15
	Size 3	P2N-CA5B	0,20
	Sandwich flow control interface function plate (for exhaust flow control - adjustment by hex. Key)		
	Size 1	P2N-GA5F	0,22
	Size 2	P2N-HA5F	0,35
	Size 3	P2N-JA5F	0,86

Dimensions

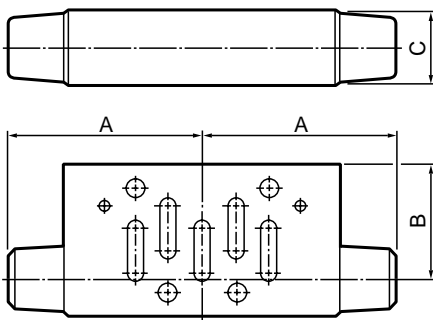

	ISO size	A	B	C	D
P2N-GA5F	1	51	30	20	89
P2N-HA5F	2	67	25	26	108
P2N-JA5F	3	89	33,5	33	122

Dimensions

Single subbase with side ports according to VDMA

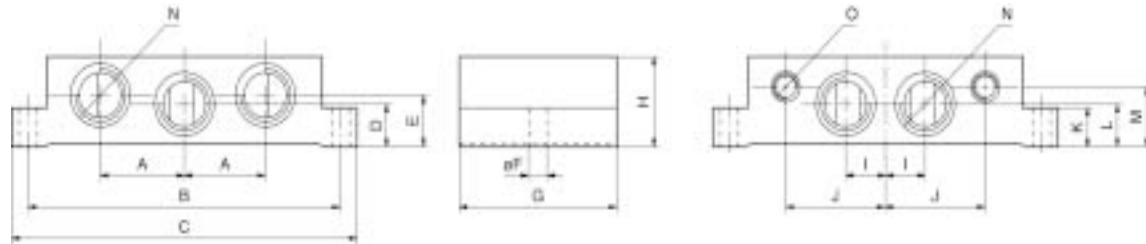

Order code	ISO Size	Port Size	A	B	C	D	E	F	G	H	I	J	K	L	M	N	O
P2N-VS512SD	1	G1/4	21,5	98	110	11	20	5,5	48	32	12	29	10	11	23	G1/4	G1/8
P2N-WS513S	2	G3/8	28	112	124	14	26	6,6	56	40	15	37	13	14	30	G3/8	G1/8
P2N-YS514SD	3	G1/2	34	136	149	17	17	6,6	71	32	16	45	18	17	22	G1/2	G1/8

Single subbase with side ports

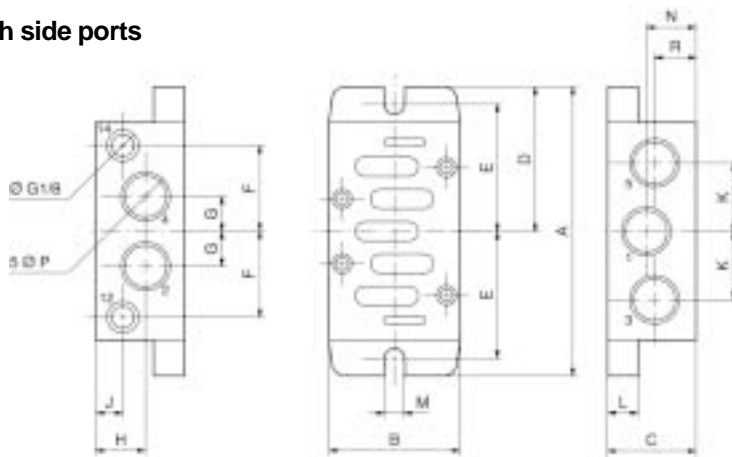

Order code	ISO Size	ØP	A	B	C	D	E	F	G	H	J	K	L	M	N	R
PL1-1/4-70	1	G1/4	110	46	29	55	49	30	11	17,75	17,75	22	6	5,5	17,75	17,75
PL2-3/8-70	2	G3/8	124	56	37	62	55	37	14,5	22,5	14	28	6	5,5	22,5	14,5
P2N-JS516SD	3	G3/4	149	71	60	74,5	68	45	21	33	10	40	18	6,6	37,5	22,5

Single subbase with bottom ports

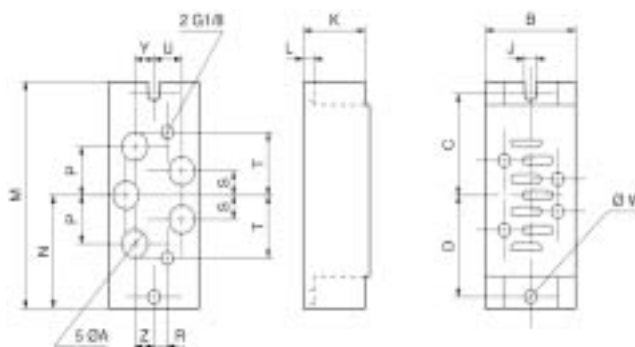

Order code	A	B	C	D	J	K	L	M	N	P	R	S	T	U	W	Y	Z
PD1-1/4-70	G1/4	46	49	49	5,5	29	6	110	55	22	10	11	30	10	5,5	10	10
PD2-3/8-70	G3/8	56	55	55	5,5	37	6	124	62	29	10	14,5	37	12,5	5,5	12,5	12,5
PD3-1/2-70	G1/2	77	68	68	6,6	32	18	149	74,5	34	10	17	45	17	6,5	17	17

Manifold and end plates according to VDMA (P2N-VM / WM / YM)

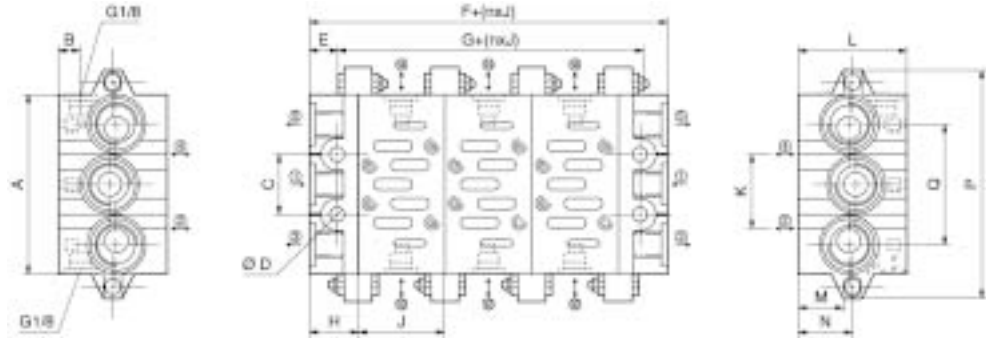

ISO Size	Port 1, 3, 5	Port 2, 4	A	B	C	D	E	F	G	H	J	K	L	M	N	O	P
1	G3/8	G1/4	85	8,5	28	7	11	44	22	22	43	26	46	21	24	56	110
2	G1/2	G3/8	100	9	35	9	13	52	26	26	56	30	47	22	24	68	135
3	G1	G1/2	140	10	52	12	15	60	30	30	71	38	56	31	34	104	190

Manifold and end plates with bottom ports "low profile" (P2N-AM..)

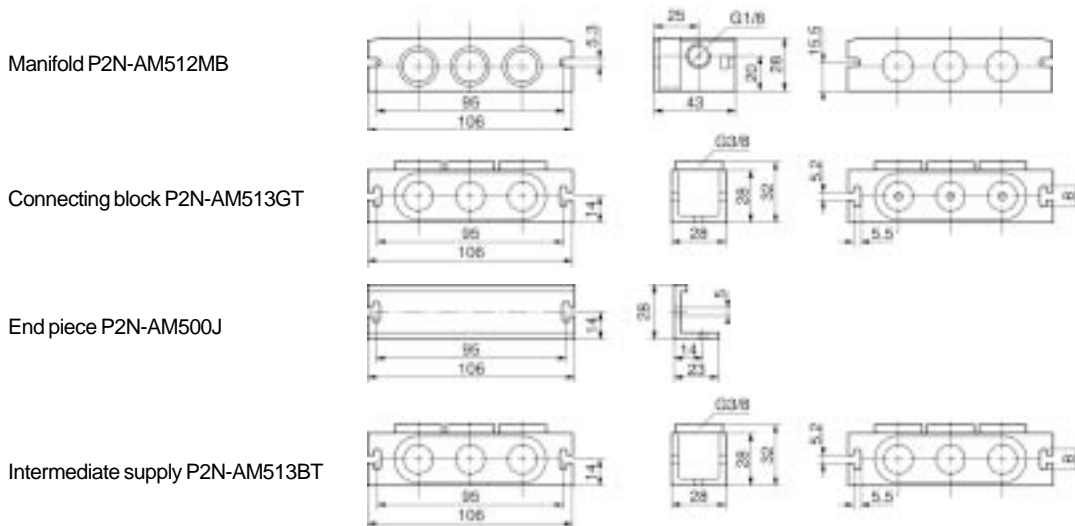

Manifold and end plates with side ports (P2N-EM / FM..)

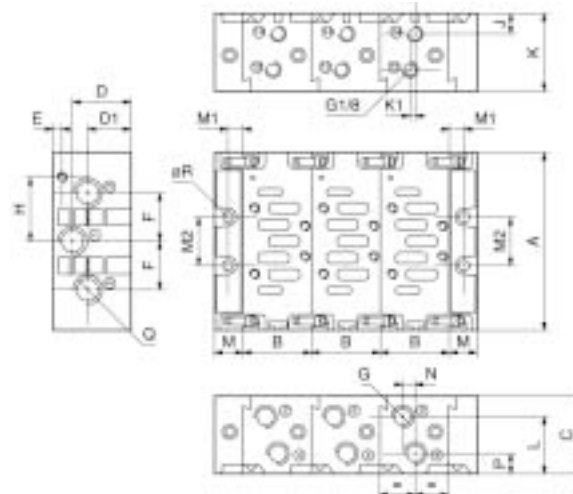

Order code	A	B	C	D	D1	E	F	G	H	J	K	K1	L	M	M1	M2	N	P	Q	R
P2N-EM ...	110	43	48	35,5	26,5	5,5	28	G1/4	36	15,5	35	3	32	20	11	28	12	12,5	G3/8	6
P2N-FM ...	129	56	60	44,5	35,5	6	34,5	G3/8	45	16	41,5	3	41	24	13	35	12,5	16	G1/2	8