

PVL Inline Valves

Catalogue No.

GB-ca



- High flow, compact size
- Push-in or threaded connection
- DIN rail or block mounting
- Light weight construction
- Inline stand alone or stackable version
- Available in 2 x 3/2 - 5/3 (PVL-B/C)

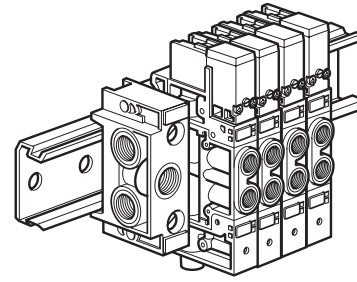





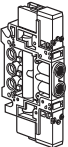

Operating information

Working pressure:								
Pneumatically operated:	2-10 bar		Flow:	Qmax	PVL-A	PVL-B	PVL-C	
Electrically operated, bistable:	2-10 bar		(acc. to ISO 6358)		270	900	1800 l/s	
Electrically operated, monostable:	3-10 bar		Flow measured with valve on manifold					
Working temperature	-15 °C to +60 °C							

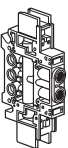
Main data for PVL-A directional control valves

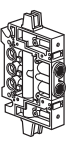
Stackable version

Symbol	Connec-Actuator tion	Return	Signal pressure min, bar at 6 bar actua./return	Changeover time, ms at 6 bar actua./return	Weight Kg	Order code	D
Electrically actuated 5/2 valves							
Complete with 0,9 W 24 VDC, miniature solenoid, LED indication and Plug-in connector with 2 m cable							
	Ø4 mm Electric M5	Electric	1,0/1,0 1,0/1,0	12/12 12/12	0,070 0,070	PVL-A122304B40 PVL-A122315B40	1 1
	Ø4 mm Electric M5	Spring	2,2/1,2 2,2/1,2	12/24 12/24	0,060 0,060	PVL-A121304B50 PVL-A121315B50	1 1
Without miniature solenoid actuator							
	Ø4 mm Electric M5	Electric	1,0/1,0 1,0/1,0	12/12 12/12	0,070 0,070	PVL-A122304 PVL-A122315	3 3
	Ø4 mm Electric M5	Spring	2,2/1,2 2,2/1,2	12/24 12/24	0,060 0,060	PVL-A121304 PVL-A121315	3 3
Pneumatically actuated 5/2 valves							
	Ø4 mm Air M5	Air	1,0/1,0 1,0/1,0	10/10 10/10	0,070 0,070	PVL-A122104 PVL-A122115	1 1
	Ø4 mm Air M5	Spring	2,2/1,2 2,2/1,2	10/22 10/22	0,060 0,060	PVL-A121104 PVL-A121115	1 1

* Each valve is supplied with two tie rods for use in the "stacking" system

Main data for PVL-B/C directional control valves

Stackable version

Symbol	Conne-Actuator tion	Return	Signal pressure min, bar at 6 bar actua./return	Changeover time, ms at 6 bar actua./return	Weight Kg	Order code	D
--------	------------------------	--------	--	---	--------------	------------	---

Electrically/pneumatically actuated 5/2 valves

Size G1/8

For use with 1,2 W / 1,6 VA miniature solenoid actuator or air-pilot connector

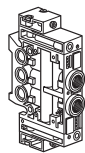

	Ø6 mm Electric	Electric	0,7/0,7	12/12	0,120	PVL-B122606	1
	G1/8 or Air	or Air	0,7/0,7	12/12	0,120	PVL-B122618	1
	Ø6 mm Electric	Spring	2,8/1,2	15/30	0,125	PVL-B121606	1
	G1/8 or Air	or Air	2,8/1,2	15/30	0,125	PVL-B121618	1
	Ø6 mm Electric	Air-spring	3,7/2,1	20/25	0,125	PVL-B123606	3
	G1/8 or Air	or Air	3,7/2,1	20/25	0,125	PVL-B123618	3

Electrically actuated 5/3 valves

Ø6 mm Electric	Electric	Electric			0,130	PVL-B127606	3
G1/8 Closed centre	Closed centre	Self centering			0,130	PVL-B127618	3
Ø6 mm Electric	Electric	Electric			0,130	PVL-B128606	3
G1/8 Vented centre	Vented centre	Self centering			0,130	PVL-B128618	3

Electrically/pneumatically actuated 2 x 3/2 valves

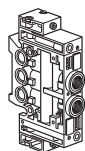

	Ø6 mm Electric	Electric	2,3/4,5	7/15	0,130	PVL-B125606	1
	or Air	or Air					
	G1/8 Electric	Electric	2,3/4,5	7/15	0,130	PVL-B125618	1
	or Air	or Air					

Electrically/pneumatically actuated 5/2 valves

Size G1/4

For use with 1,2 W / 1,6 VA miniature solenoid actuator or air-pilot connector

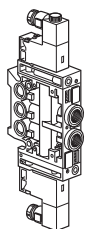

	Ø8 mm Electric	Electric	0,9/0,9	17/17	0,230	PVL-C122608	1
	G1/4 or	or	0,9/0,9	17/17	0,230	PVL-C122619	3
	G3/8 Air	Air	0,9/0,9	17/17	0,230	PVL-C122613	3
	Ø8 mm Electric	Spring	2,8/1,0	25/60	0,240	PVL-C121608	1
	G1/4 or	or	2,8/1,0	25/60	0,240	PVL-C121619	1
	G3/8 Air	Air	2,8/1,0	25/60	0,240	PVL-C121613	1
	Ø8 mm Electric	Air-spring	3,5/2,3	30/50	0,240	PVL-C123608	3
	G1/4 or	or	3,5/2,3	30/50	0,240	PVL-C123619	3
	G3/8 Air	Air	3,5/2,3	30/50	0,240	PVL-C123613	3

Electrically actuated 5/3 valves

Ø8 mm Electric	Electric	Electric			0,250	PVL-C127606	3
G1/4 Closed centre	Closed centre	Self centering			0,250	PVL-C127618	3
Ø8 mm Electric	Electric	Electric			0,250	PVL-C128606	3
G1/4 Vented centre	Vented centre	Self centering			0,250	PVL-C128618	3

Size G1/4

For use with 6 W / 8,5 VA solenoid actuator or air-pilot connector

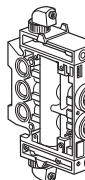

	Ø8 mm Electric	Electric	0,9/0,9	15/15	0,240	PVL-C122408	3
	G1/4 or	or	0,9/0,9	15/15	0,240	PVL-C122419	3
	Air	Air					
	Ø8 mm Electric	Spring	2,8/1,0	20/50	0,250	PVL-C121408	1
	G1/4 or	or	2,8/1,0	20/50	0,250	PVL-C121419	1
	Air	Air					
	Ø8 mm Electric	Air-spring	3,5/2,3	25/45	0,250	PVL-C123408	3
	G1/4 or	or	3,5/2,3	25/45	0,250	PVL-C123419	3
	Air	Air					







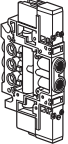
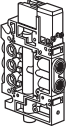

* Each valve is supplied with two tie rods for use in the "stacking" system

** The above valve operation can be either:

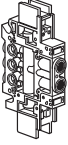
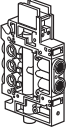
- Pneumatic, with the addition of one or two pilot connectors complete with Ø4 mm Push-in connections
- Electrical, with the addition of one or two 1 W solenoid (PVL-B), 1 W or 5 W solenoids (PVL-C)

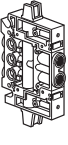
Main data for PVL-A directional control valves

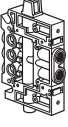
Stand alone version

	Symbol	Connec-Actuator tion Push-in/ Threaded	Return	Signal pressure min, bar at 6 bar actua./return	Changeover time, ms at 6 bar actua./return	Weight Kg	Order code	D
Electrically actuated 5/2 valves								
Complete unit 0,9 W 24 VDC miniature solenoid, LED indication and plug-in connector with 2 m cable								
		Ø4 mm Electric M5	Electric	1,0/1,0 1,0/1,0	12/12 12/12	0,070 0,070	PVL-A112304B40 PVL-A112315B40	3 3
		Ø4 mm Electric M5	Spring	2,2/2,2 2,2/2,2	12/24 12/24	0,060 0,060	PVL-A111304B50 PVL-A111315B50	1 3
Without miniature solenoid actuator								
		Ø4 mm Electric M5	Electric	1,0/1,0 1,0/1,0	12/12 12/12	0,070 0,070	PVL-A112304 PVL-A112315	3 3
		Ø4 mm Electric M5	Spring	2,2/1,2 2,2/1,2	12/24 12/24	0,060 0,060	PVL-A111304 PVL-A111315	3 3
Pneumatically actuated 5/2 valves								
		Ø4 mm Air M5	Air	1,0/1,0 1,0/1,0	10/10 10/10	0,070 0,070	PVL-A112104 PVL-A112115	3 3
		Ø4 mm Air M5	Spring	2,2/1,0 2,2/1,0	10/22 10/22	0,060 0,060	PVL-A111104 PVL-A111115	3 3

Mounting

The valves have integral mounting holes suitable for M4 screws and can be directly mounted on to any suitable surface. The pipework connections will be either use of threaded fittings or direct Push-in depending on the body selected.

Main data for PVL-B/C directional control valves

Stand alone version

Symbol	Conne ^c -Actuator tion Push-in/ Threaded	Return	Signal pressure min, bar at 6 bar actua./return	Changeover time, ms at 6 bar actua./return	Weight Kg	Order code	D
--------	--	--------	--	---	--------------	------------	---

Electrically/pneumatically actuated 5/2 valves

Size G1/8

For use with 1,2 W / 1,6 VA miniature solenoid actuator or air-pilot connector

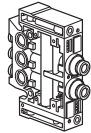

	Ø6 mm	Electric	Electric	0,7/0,7	12/12	0,120	PVL-B112606	1
	G1/8	or Air	or Air	0,7/0,7	12/12	0,120	PVL-B112618	1
	Ø6 mm	Electric	Spring	2,8/1,2	15/30	0,125	PVL-B111606	1
	G1/8	or Air		2,8/1,2	15/30	0,125	PVL-B111618	1
	Ø6 mm	Electric	Air spring	3,7/2,1	20/35	0,125	PVL-B113606	3
	G1/8	or Air		3,7/2,1	20/35	0,125	PVL-B113618	3

Electrically actuated 5/3 valves

Ø6 mm	Electric	Electric				0,130	PVL-B117606	3
G1/8	Closed centre	Self centering				0,130	PVL-B117618	3
Ø6 mm	Electric	Electric				0,130	PVL-B118606	3
G1/8	Vented centre	Self centering				0,130	PVL-B118618	3

Electrically/pneumatically actuated 2 x 3/2 valves

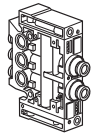

	Ø6 mm	Electric	Internal air	2,3/4,5	7/15	0,130	PVL-B115606	3
		or Air						
	G1/8	Electric	Internal air	2,3/4,5	7/15	0,130	PVL-B115618	3
		or Air						

Size G1/4

For use with 1,2 W / 1,6 VA miniature solenoid actuator or air-pilot connector

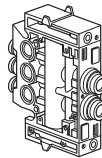

	Ø8 mm	Electric	Electric	0,9/0,9	17/17	0,230	PVL-C112608	3
	G1/4	or	or	0,9/0,9	17/17	0,230	PVL-C112619	3
	G3/8	Air	Air	0,9/0,9	17/17	0,230	PVL-C112613	3
	Ø8 mm	Electric	Spring	2,8/1,0	25/60	0,240	PVL-C111608	1
	G1/4	or		2,8/1,0	25/60	0,240	PVL-C111619	3
	G3/8	Air		2,8/1,0	25/60	0,240	PVL-C111613	3
	Ø8 mm	Electric	Air spring	3,5/2,3	30/50	0,240	PVL-C113608	3
	G1/4	or		3,5/2,3	30/50	0,240	PVL-C113619	3
	G3/8	Air		3,5/2,3	30/50	0,240	PVL-C113613	3

Electrically actuated 5/3 valves

Ø8 mm	Electric	Electric				0,250	PVL-C117608	3
G1/4	Closed centre	Self centering				0,250	PVL-C117619	3
Ø8 mm	Electric	Electric				0,250	PVL-C118608	3
G1/4	Vented centre	Self centering				0,250	PVL-C118619	3

Size G1/4

For use with 6 W / 8,5 VA solenoid actuator or air-pilot connector

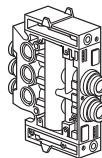

	Ø8 mm	Electric	Electric	0,9/0,9	15/15	0,240	PVL-C112408	3
	G1/4	or Air	or Air	0,9/0,9	15/15	0,240	PVL-C112419	3
	Ø8 mm	Electric	Spring	2,8/1,0	20/50	0,250	PVL-C111408	3
	G1/4	or Air		2,8/1,0	20/50	0,250	PVL-C111419	3
	Ø8 mm	Electric	Air spring	3,5/2,3	25/45	0,250	PVL-C113408	3
	G1/4	or Air		3,5/2,3	25/45	0,250	PVL-C113419	3

The above valve operation can be either:

- Pneumatic, with the addition of one or two pilot connectors complete with Ø4 mm Push-in connections
- Electrical, with the addition of one or two 1 W or 5W solenoid actuators

Mounting

The valves have integral mounting holes suitable for M4 screws and can be directly mounted onto any suitable surface. The pipework connections will be either use of threaded fittings or direct Push-in depending on the body selected.

Modular piloting system

M5, G1/8 and G1/4 sizes

Basic component
PVL-A1**3**

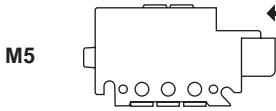

M5

Electrically actuated

Pneumatic piloting connectors

Solenoid actuators

PVA-J***



- Power 0,9 W

PVL-A1**1**

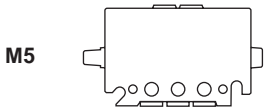

M5

Pneumatically actuated

Integral Ø4 mm
Push-in connection

PVL-B1**6**

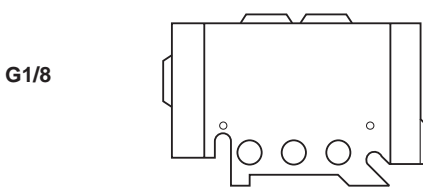

G1/8

PVL-C1**6**

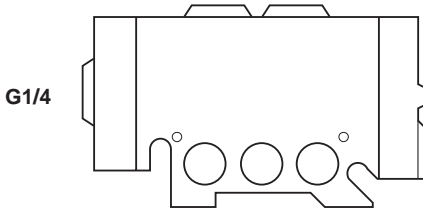

G1/4

or

or

Ø4 mm Push-in
connection
PVA-P11•

PVA-H249**

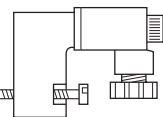

- Power: 1,2 W 1,6 VA ~

- Electrical connector: 15x15 mm

- Optional suppressor and indicator PS1-E1**

PVL-C1**4**

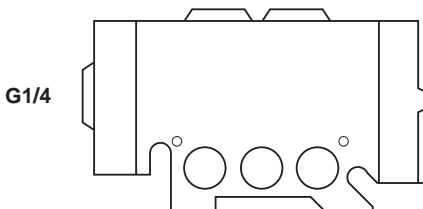

G1/4

or

Ø4 mm Push-in
connection
PVA-P12•

PVA-F10** or PVA-F50

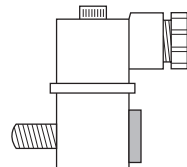

- Power: 6 W 8,5 VA ~ or
2,5 W 3,5 VA

- Electrical
connector: 22x30 mm

0,9W miniature solenoid with built-in indicator, IP 40

Spring return manual override
Actuator only

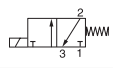

Voltage		Order code	D
12 VDC		PVA-J1302J9	3
24 VDC		PVA-J1302B9	3

Indexable manual override
Actuator only

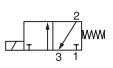

Voltage		Order code	D
12 VDC		PVA-J1352J9	3
24 VDC		PVA-J1352B9	3

Without manual override
Actuator only

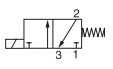

Voltage		Order code	D
12 VDC		PVA-J1392J9	3
24 VDC		PVA-J1392B9	3

Spring return manual override
With unwired 10 mm cable connector

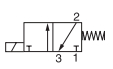

Voltage		Order code	D
12 VDC		PVA-J1302J	3
24 VDC		PVA-J1302B	3

Indexable manual override
With unwired 10 mm cable connector

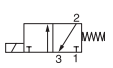

Voltage		Order code	D
12 VDC		PVA-J1352J	3
24 VDC		PVA-J1352B	3

Without manual override
With unwired 10 mm cable connector

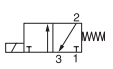

Voltage		Order code	D
12 VDC		PVA-J1392J	3
24 VDC		PVA-J1392B	3

Spring return manual override
With prewired 10 mm cable connector, cable length L=2 m

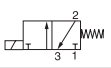

Voltage		Order code	D
12 VDC		PVA-J1302J0	3
24 VDC		PVA-J1302B0	3

Indexable manual override
With prewired 10 mm cable connector, cable length L=2 m

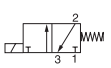

Voltage		Order code	D
12 VDC		PVA-J1352J0	3
24 VDC		PVA-J1352B0	3

Without manual override
With prewired 10 mm cable connector, cable length L=2 m

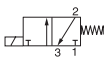

Voltage		Order code	D
12 VDC		PVA-J1392J0	3
24 VDC		PVA-J1392B0	3

Spring return manual override
With prewired 10 mm cable connector, cable length L=5 m

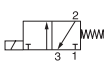

Voltage		Order code	D
12 VDC		PVA-J1302J1	3
24 VDC		PVA-J1302B1	3

Indexable manual override
With prewired 10 mm cable connector, cable length L=5 m

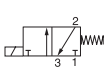

Voltage		Order code	D
12 VDC		PVA-J1352J1	3
24 VDC		PVA-J1352B1	3

Without manual override
With prewired 10 mm cable connector, cable length L=5 m

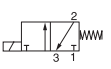

Voltage		Order code	D
12 VDC		PVA-J1392J1	3
24 VDC		PVA-J1392B1	3

Wiring and connecting accessories, please see next page

To order solenoid actuators with built-in overvoltage limiter (for control circuit protection), replace the first digit in the numerical part of the reference by **5**. Example: **PVA-J5352B**

Wiring and connecting accessories for PVL-A

Connector 2 x 0,128 mm ²	Order code	D
Connector only (sold in pack of 10 pcs)	PES-D10	3
Connector with 2 m cable	PES-D100	3
Connector with 5 m cable	PES-D101	3
Connector with 10 m cable	PES-D102	3
Terminal to be crimped (sold in pack of 10 pcs)	SY3CM0142	3

Solenoids 15 mm 1,2 W / 1,6 VA (9,4 mm pin spacing),

Without manual override



Without cable connector

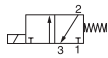

Voltage	Order code	D
12 VDC	PS1-E2492J	3
24 VDC	PS1-E2492B	3
48 VDC	PS1-E2492E	3
24 V 50/60Hz	PS1-E2491B	3
48 V 50/60Hz	PS1-E2491E	3
115 V 50Hz, 120 V 60Hz	PS1-E2491F	3
230 V 50Hz, 240 V 60Hz	PS1-E2491M	3



With prewired 15 mm cable connector, cable length L=2 m

Voltage	Order code	D
24 VDC	PVA-H2492B0	3
48 VDC	PVA-H2492E0	3
24 V 50/60Hz	PVA-H2491B0	3
48 V 50/60Hz	PVA-H2491E0	3
115 V 50Hz, 120 V 60Hz	PVA-H2491F0	3
230 V 50Hz, 240 V 60Hz	PVA-H2491M0	3

With unwired 15 mm cable connector

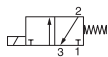

Voltage	Order code	D
24 VDC	PVA-H2492B	1
48 VDC	PVA-H2492E	3
24 V 50/60Hz	PVA-H2491B	1
48 V 50/60Hz	PVA-H2491E	3
115 V 50Hz, 120 V 60Hz	PVA-H2491F	1
230 V 50Hz, 240 V 60Hz	PVA-H2491M	3



With prewired 15 mm cable connector, cable length L=5 m

Voltage	Order code	D
24 VDC	PVA-H2492B1	3
48 VDC	PVA-H2492E1	3
24 V 50/60Hz	PVA-H2491B1	3
48 V 50/60Hz	PVA-H2491E1	3
115 V 50Hz, 120 V 60Hz	PVA-H2491F1	3
230 V 50Hz, 240 V 60Hz	PVA-H2491M1	3

Electrical connector 15x15mm (9,4 mm pin spacing)	Order code	D
Connector to be wired (universal)	PES-C10	3
Connector to be wired with LED+Protection	PES-C2020B	3
24 V DC/AC		

Electrical connector 15x15mm (9,4 mm pin spacing)	Order code	D
Connector with 2 m cable (earth terminal opposite cable)	PES-C12	3
Connector with 2 m cable with LED+Protection (earth terminal opposite cable) 24 V DC/AC	PES-C2220B	3

Multi-subbases for solenoid actuators 3/2 PS1-E24...

Operating pressure 0 to 10 bar

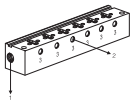

	Connections	Number of positions	Weight Kg	Order code	D	
	common air supply	2	0,095	PVU-H13152	3	
		4	0,150	PVU-H13154	3	
		6	0,200	PVU-H13156	3	
	1 G1/8	8	0,255	PVU-H13158	3	
		2 M5	10	0,310	PVU-H131510	3

Air Pilot Connectors

	Mounting	Type of connection	Weight Kg	Order code	D
	Mounts on the same interface as the 1 W / 1,2 VA solenoid actuator	Push-in Ø4 mm	0,007	PVA-P111	1
		Threaded M5	0,002	PVA-P115	3

Intermediate Air Pilot Connectors

For mounting between the PVA-H24I solenoid actuator and the PVL-BI or PVL-CI power valve 5/2 mounted on DIN rail

	Description	Type of connection	Weight Kg	Order code	D
	For pneumatic piloting of the power valve	Straight, Push-in Ø4 mm	0,040	PVA-P171	3
	For external air supply to the 1 W / 1,2 VA miniature solenoid actuators	Swivel, Push-in Ø 4 mm	0,040	PVA-P161	1
		Straight, Push-in Ø 4 mm	0,040	PVA-P163	3

Solenoids 6 W / 8,5 VA

Without manual override



Without cable connector (22x30 mm)

Voltage		Order code	D
12 VDC		PVA-F192J	3
24 VDC		PVA-F192B	1
48 VDC		PVA-F192E	3
24 V 50/60Hz		PVA-F191B	3
48 V 50/60Hz		PVA-F191E	3
115 V 50Hz, 120 V 60Hz		PVA-F191F	3
230 V 50Hz, 240 V 60Hz		PVA-F191M	3



With unwired cable connector (22x30 mm)

Voltage		Order code	D
24 VDC		PVA-F102B	1
48 VDC		PVA-F102E	3
24 V 50/60Hz		PVA-F101B	1
48 V 50/60Hz		PVA-F101E	3
115 V 50Hz, 120 V 60Hz		PVA-F101F	1
230 V 50Hz, 240 V 60Hz		PVA-F101M	1
255 V 50Hz		PVA-F101U	3

* Versions available for use in explosive atmospheres:
 - conforming to certification LCIE 866115 X,
 - electrical equipment conforming to harmonised European standards



EN 500 14 dated March 1977 (NFC23 514 dated May 1982)
 EN 500 19 dated March 1977 (NFC23 519 dated May 1982)
 - marking code EExe II T4 (consult your Technical Sales Office)

With prewired cable connector (22x30 mm), cable length L=2 m

Voltage		Order code	D
24 VDC		PVA-F102B0	3
48 VDC		PVA-F102E0	3
24 V 50/60Hz		PVA-F101B0	3
48 V 50/60Hz		PVA-F101E0	3
115 V 50Hz, 120 V 60Hz		PVA-F101F0	3
230 V 50Hz, 240 V 60Hz		PVA-F101M0	3
255 V 50Hz		PVA-F101U0	3



With prewired cable connector (22x30 mm), cable length L=5 m

Voltage		Order code	D
24 VDC		PVA-F102B1	3
48 VDC		PVA-F102E1	3
24 V 50/60Hz		PVA-F101B1	3
48 V 50/60Hz		PVA-F101E1	3
115 V 50Hz, 120 V 60Hz		PVA-F101F1	3
230 V 50Hz, 240 V 60Hz		PVA-F101M1	3
255 V 50Hz		PVA-F101U1	3

Electrical connector 22x30 mm	Order code	D
Connector to be wired (universal)	PES-A10	3
Connector to be wired with LED+Protection 24 V DC/AC	PES-A2020B	1
Connector to be wired with LED+Protection 230 VAC	PES-A2001M	3
Connector with 2 m cable (earth terminal opposite cable)	PES-A12	3
Connector with 2 m cable with LED+Protection (earth terminal opposite cable) 24 V DC/AC	PES-A2220B	3

Air Pilot Connectors



Mounting	Type of connection	Weight Kg	Order code	D
 Mounts on the same interface as the 5 W / 6 VA solenoid actuator	Push-in Ø4 mm, elbow	0,004	PVA-P121	3
	Push-in Ø4 mm, swivel	0,007	PVA-P122	3
	Threaded M5	0,004	PVA-P125	3

Head and tail sets

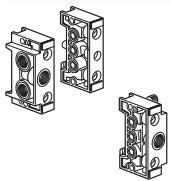
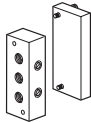
For stacking power valves 5/2, sizes M5, G1/8 and G1/4

	Type of mounting	Description	Valve size	Port size	Weight Kg	Order code	D
	DIN rail mounting	Single air supply head and tail set	M5	G1/8	0,065	PVL-A1718	1
			1/8"	G1/4	0,175	PVL-B1719	1
			1/4"	G3/8	0,195	PVL-C1713	1
	Dual air supply head and tail set	M5	G1/4	0,080	PVL-A1728	1	
		1/8"	G1/4	0,245	PVL-B1729	1	
		1/4"	G3/8	0,285	PVL-C1723	1	
	Surface mounting	Dual air supply head and tail set	1/8"	G1/8	0,200	PVL-B1818	3
			1/4"	G1/4	0,225	PVL-C1819	3
	Dual air supply head and tail set	1/8"	G1/8	0,260	PVL-B1828	3	
		1/4"	G1/4	0,280	PVL-C1829	3	

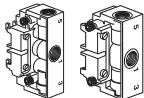
Components for stacking two sizes of power valve

	Type of mounting	Description	Valve size	Weight Kg	Order code	D
Components for stacking 2 sizes: "transfer/take-off" module and corresponding head and tail set						
	On DIN rail	Kit for stacking power valves : - one "transfer/take-off" module - two head and tail sets with one in each size.	M5 and 1/8"	0,120	PVU-LBA118	3
			1/8" and 1/4"	0,642	PVU-LCB119	3
Components for intermediate supply						
	On DIN rail	Intermediate supply module	1/8"		PVU-LBB118	3
			1/4"		PVU-LCC119	3
Components for inlet/exhaust common gallery sealing						
		Kit for sealing the commons: - 3 common blanking plugs - 2 drilled and threaded rods - 2 screws for extended tie rods	M5	0,020	PVL-A1901	1
			1/8"	0,035	PVL-B1901	1
			1/4"	0,065	PVL-C1901	3

Spare Mounting and assembly kits

	Contents	Valve size	Base component	Weight Kg	Order code	D
- Seals for common inlet/exhaust ports	1 pack of 30 O-ring seals	1/8"	PVL-B17•• PVL-B18•• PVL-B12••••	0,009	PPR-V23	3
		1/4"	PVL-C17•• PVL-C18•• PVL-C12••••	0,017	PPR-V24	3
- Seals for pneumatic piloting or solenoid actuator connectors	1 pack of 50 O-ring seals for pneumatic piloting connectors type PVA-P12•		PVA-P122 PVA-P121 PVA-P125	0,007	PPR-V25	3
	1 pack of 20 seals for solenoid actuator type PVA-H24 and pneumatic piloting connector type PVA-P11•		PVL-B11•6•• PVL-B12•6•• PVL-C11•6•• PVL-C12•6••	0,004	PPR-V20	1
- Fixing accessories	1 pack of 20 hooks for head and tail modules		PVL-B17•• PVL-C17••	0,110	PPR-L09	1
	1 pack of 10 stacking rods for 1/8" power valves		PVL-B12••••	0,040	PPR-V21	1
	1 pack of 10 stacking rods for 1/4" power valves		PVL-C12••••	0,058	PPR-V22	1



Dimensions, PVL valve Series

All dimensions in mm unless otherwise stated

M5 stand-alone power valves with pneumatic or electrical piloting

Electrical piloting with 0,9 W solenoid actuator

Monostable PVL-A1113**

Bistable PVL-A1123**

Pneumatic piloting

Monostable PVL-A1111**

Bistable PVL-A1121**

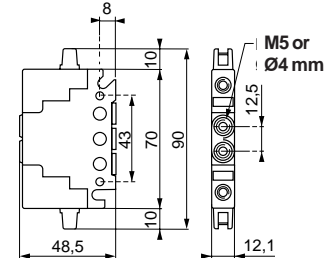
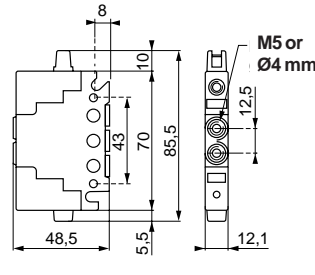
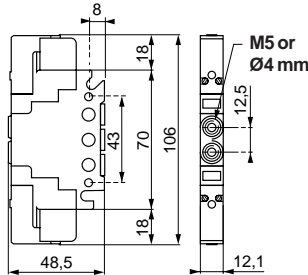
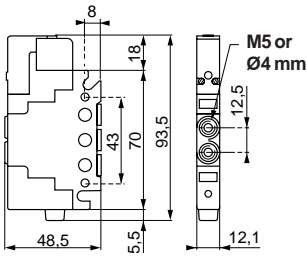

M5 stand-alone power valves with pneumatic or electrical piloting

Electrical piloting with 0,9 W solenoid actuator

Monostable PVL-A1213**

Bistable PVL-A1223**

Pneumatic piloting

Monostable PVL-A1211**

Bistable PVL-A1221**

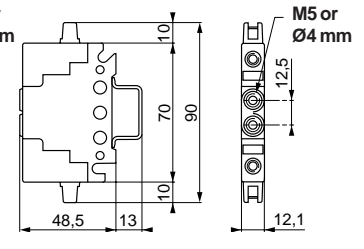
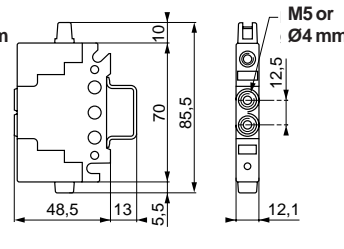
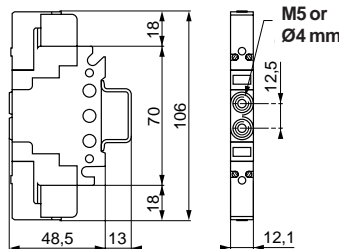
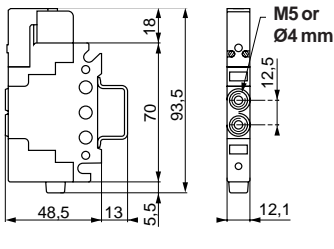

Head and tail sets

- Mounting on DIN rail

Single air supply PVL-A1718

Dual air supply PVL-A1728

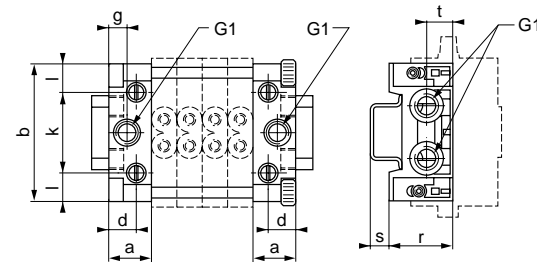
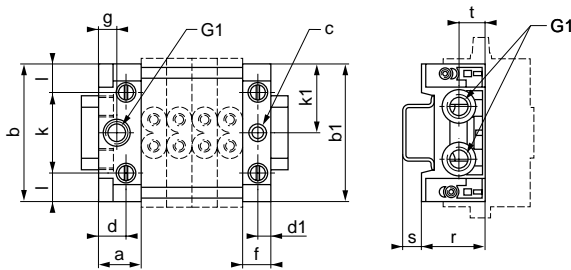

Thread size	a	b	b1	c	d	d1	f	g	G1	k	k1	l	r	s	t
M5	20	65	65	4,2	12,9	5,9	13	8,5	1/8"	38	38	13,5	30	8,8	12,5

"Transfer / take-off module"

For combination of M5 - 1/8" sizes - PVU-LBA118

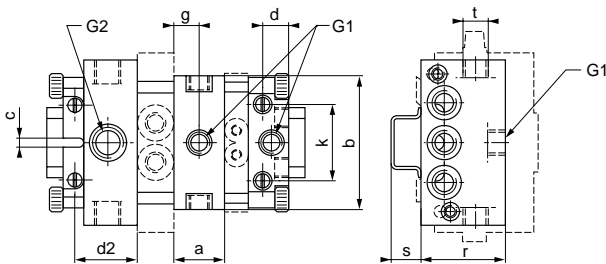

Thread size	a	b	c	d	d2	g	G1	G2	k	r	s	t
G1/8 - M5	25	67	4,2	12,9	31,3	12,5	1/8"	1/4"	38	34	14,8	11,9

Stand-alone power valves 1/8" without piloting accessories

Monostable PVL-B1116**, PVL-B1136**

Bistable PVL-B1126**

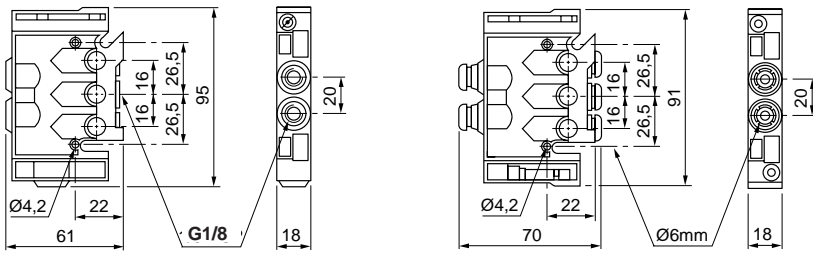

Stacking power valves 1/8" with pneumatic or electrical piloting

Monostable PVL-B1216**, PVL-B1236**

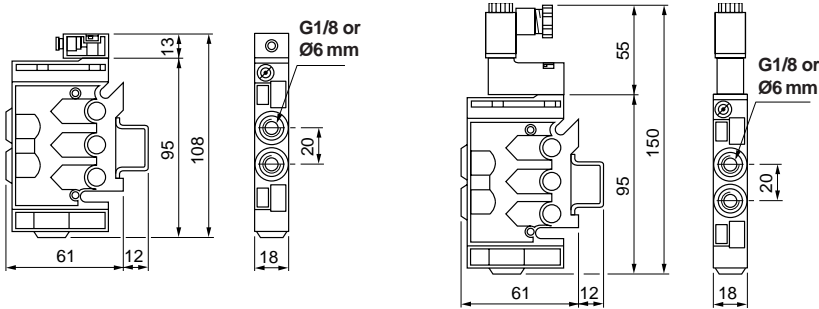

Bistable PVL-B1226**

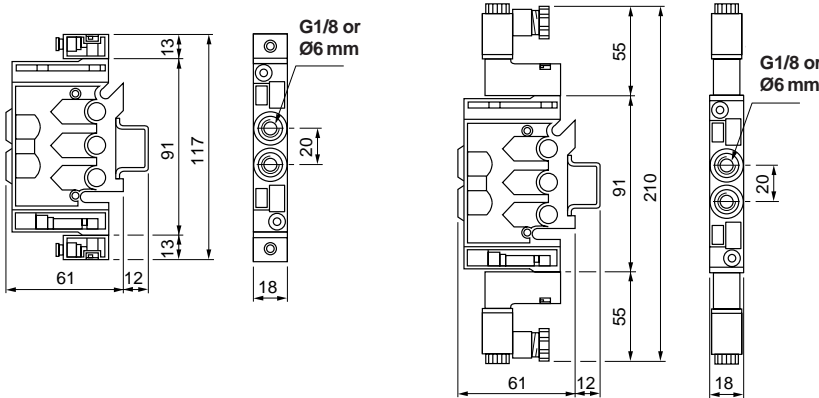

Stand-alone power valves 1/4" without piloting accessories
Monostable PVL-C1116, PVL-C1136**, PVL-C1114**, PVL-C1134****

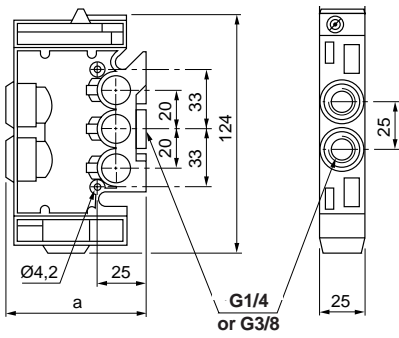

Bistable PVL-C1126, PVL-C1124****

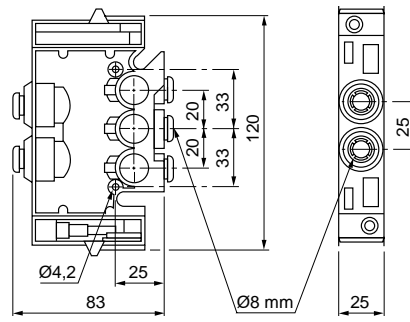

	G1/4	G3/8
a	73	88

Stacking power valves 1/4" with pneumatic or electrical control
With 1 W solenoid actuator and suitable pneumatic connector
Monostable PVL-C1216, PVL-C1236****

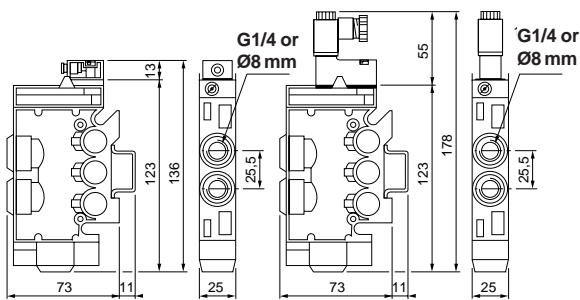

Bistable PVL-C1226**

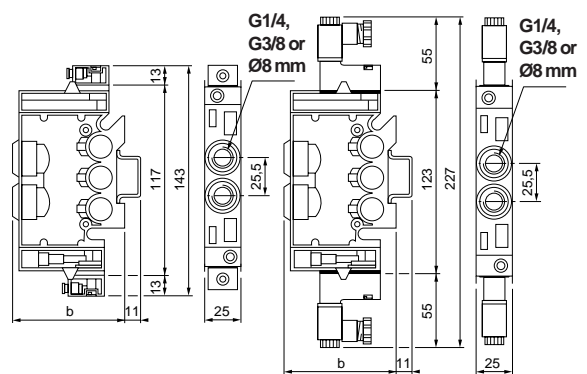

	G1/4	G3/8
b	73	77

With 5W solenoid actuator and suitable pneumatic connector
Monostable PVL-C1214, PVL-C1234****

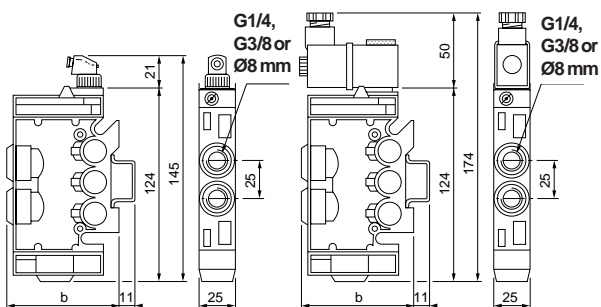

Bistable PVL-C1224**

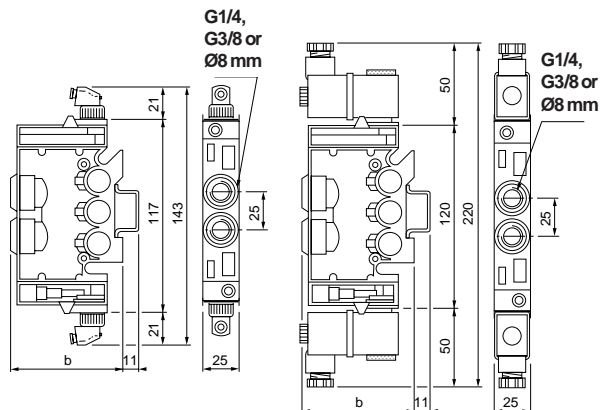

Head and tail sets

Single air supply

PVL-B1719, PVL-C1713, mounting on DIN rail

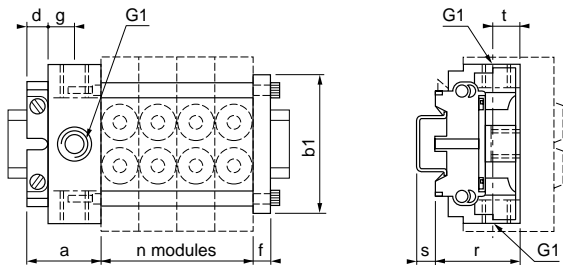

Dual air supply

PVL-B1729, PVL-C1723, mounting on DIN rail

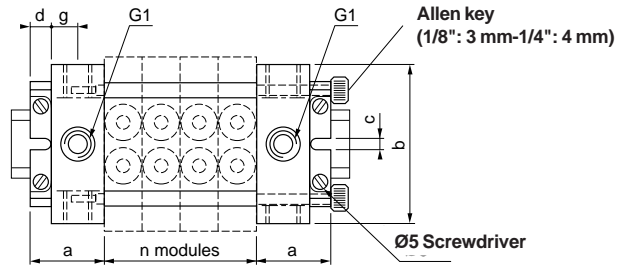

Single air supply

PVL-B1818, PVL-C1819, "stack mounting"

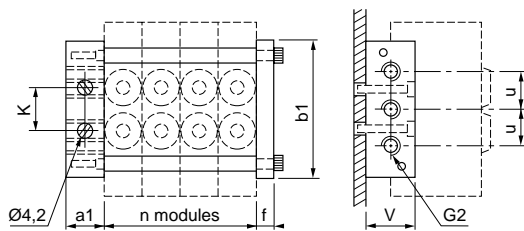

	a	a1	b	b1	c	d	f	g	G1	G2	k	r	s	t	u	v
1/8"	38	16	83	70	4,2	10	8	12	1/4"	1/8"	17,3	44	9	11	16	25
1/4"	38	20	108	100	4,2	10	8	12	3/8"	1/4"	63,5	55	9	13	20	30

"Transfer / take-off" module, intermediate supply module

For combination of sizes 1/4" - 1/8" - PVU-LCB119

PVUL-BB118 - PVU-LCC119

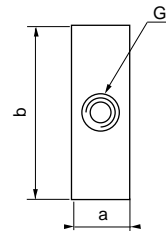
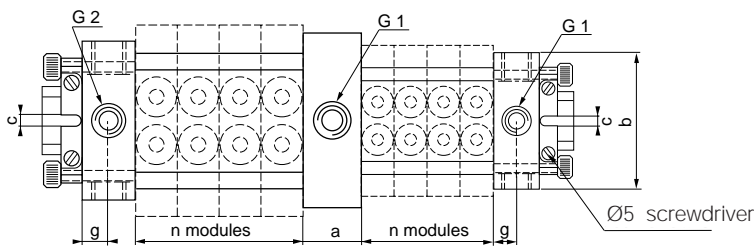

	a	b	G
1/8"	18	75	1/8"
1/4"	25	100	1/4"

Intermediate piloting connectors

PVA-P171

PVA-P161

PVA-P163

